



**Kenya National Highways Authority**

*Quality Highways, Better Connections*

**TENDER No. KeNHA/R4/304/2024**

**PERIODIC MAINTENANCE OF KAMPI YA MOTO - EMINING (B17) ROAD  
(Reserved for All)**

**FEBRUARY, 2024**

**DIRECTOR MAINTENANCE  
KENYA NATIONAL HIGHWAYS  
AUTHORITY  
P.O. BOX 49712-00100  
NAIROBI**

**DIRECTOR GENERAL  
KENYA NATIONAL HIGHWAYS  
AUTHORITY  
P.O. BOX 49712-00100  
NAIROBI**

**D. Contents**

<b>SECTION I INVITATION TO TENDER .....</b>	<b>3</b>
<b>PART 1 TENDERING PROCEDURES .....</b>	<b>7</b>
SECTION II - INSTRUCTIONS TO TENDERERS .....	8
SECTION III - TENDER DATA SHEET (TDS).....	26
SECTION IV- EVALUATION AND QUALIFICATION CRITERIA .....	30
SECTION V - TENDERING FORMS .....	48
FORM ELI-1.1- TENDERER INFORMATION FORM .....	49
FORM ELI- 1.2- TENDERER JV INFORMATION .....	50
FORM ELI - 1.3- QUALIFICATION OF FOREIGN CONTRACTORS .....	51
FORM ELI - 1.4- DECLARATIONS OF MATERIALS, EQUIPMENT AND LABOUR SOURCES ...	53
FORM OF TENDER .....	54
FORM CON – 1 HISTORICAL CONTRACT NON-PERFORMANCE, PENDING LITIGATION AND LITIGATION HISTORY .....	71
FORM CON – 2: DECLARATION FORM – FAIR EMPLOYMENT LAW AND PRACTICES.....	72
FORM CON – 3: CERTIFICATE OF BIDDER’S VISIT TO SITE.....	73
FORM FIN – 3.1: FINANCIAL SITUATION AND PERFORMANCE .....	74
FORM FIN – 3.2: AVERAGE ANNUAL CONSTRUCTION TURNOVER .....	78
FORM FIN - 3.3: CURRENT CONTRACT COMMITMENTS / WORKS IN PROGRESS .....	79
FORM EXP - 4.1: GENERAL CONSTRUCTION EXPERIENCE .....	80
FORM EXP - 4.2(A): SPECIFIC CONSTRUCTION AND CONTRACT MANAGEMENT EXPERIENCE .....	81
FORM EXP - 4.2(B): CONSTRUCTION EXPERIENCE IN KEY ACTIVITIES .....	82
TECHNICAL PROPOSAL .....	84
FORM OF TENDER SECURITY - DEMAND GUARANTEE .....	107
<b>PART 2 - WORKS' REQUIREMENTS.....</b>	<b>108</b>
SECTION VI - BILLS OF QUANTITIES .....	109
SECTION VII - SPECIFICATIONS .....	136
SECTION VIII - DRAWINGS .....	204
<b>PART 3 – CONDITIONS OF CONTRACT AND CONTRACT FORMS .....</b>	<b>209</b>
SECTION IX CONDITIONS OF CONTRACT, PART I -GENERAL CONDITIONS.....	210
SECTION X CONDITIONS OF CONTRACT, PART II -CONDITIONS OF PARTICULAR APPLICATION	212
SECTION XI - CONTRACT FORMS .....	242
FORM NO. I - NOTIFICATION OF INTENTION TO AWARD .....	243
FORM NO. 2 - NOTIFICATION OF AWARD.....	246
FORM NO. 3 – CONTRACT AGREEMENT .....	247
FORM NO. 4 - PERFORMANCE SECURITY .....	248
FORM NO. 6 - ADVANCE PAYMENT SECURITY .....	249
FORM NO. 7 - RETENTION MONEY SECURITY .....	251
FORM NO. 8 BENEFICIAL OWNERSHIP DISCLOSURE FORM.....	252

**SECTION I**

**INVITATION TO TENDER**

## SECTION 1: INVITATION TO TENDER

### TENDER NO. KeNHA/R4/304/2024– PERIODIC MAINTENANCE OF KAMPI YA MOTO - EMINING (B17) ROAD

The Kenya National Highways Authority (KeNHA) is a State Corporation established under the Kenya Roads Act, 2007, with the responsibility for the management, development, rehabilitation and maintenance of national roads.

The Authority invites bids from eligible construction companies registered with the **National Construction Authority (NCA) in Category NCA 1, 2 or 3** for the **PERIODIC MAINTENANCE OF KAMPI YA MOTO - EMINING (B17) ROAD** to be funded through Fuel Maintenance Levy Fund (RMLF).

### SCOPE OF WORK

The scope of works shall be as described in the tender document.

### QUALIFICATION FOR TENDERING

#### Mandatory Requirements

The following **MUST** be submitted together with the bid;

1. Copy of Certificate of incorporation
2. Copy of **Valid** Annual Practising Licence with the National Construction Authority in the classes specified above
3. Copy of **Valid** Tax Compliance Certificate
4. Copy of recent CR 12 form (Issued within the last Six 6 months from the Tender Opening Date).
5. Bidders shall **sequentially serialise** all pages of each tender submitted. A Guide Note on Serialization is outlined in the Notes below

#### Other Requirements

As specified in the respective tender documents covering the following: -

1. Similar previous experience where applicable.
2. Professional and Technical Personnel.
3. Current work load.
4. Eligibility
  - a. To enhance equity, bidders shall bid for a maximum of **Two (2)** Tenders but can only be Awarded a Maximum of **One (1)** Tenders, under this Tender Notice. Bidders who participate in more than **Two (2)** tenders shall be disqualified.
  - b. Director (s) and Bidders who have been awarded Tenders in this **Financial Year (1st & 2<sup>nd</sup> Quarter Tender Notice) (FY 2023-2024)** are not eligible to bid for this Tender Notice.
  - c. Director (s) bidding under different companies for the same tender shall be disqualified
  - d. Director (s) bidding under different companies should not participate in more than **Two (2)** tenders
  - e. Only those bidders registered in the Category as indicated in the tender document shall bid for the respective tenders
  - f. Bidders to comply with section 157 (8) (a) (ii) and (ii) on exclusive preference for citizen contractors
  - g. Any form of Canvassing will lead to disqualification
5. Source of indices and base values for at least 30 days prior to tender submission

**Note:**

1. All submitted Documents may be verified from the issuing agencies, KeNHA Reserves the right to verify all submitted documents
2. The Bidders to ensure that their rates in the bills of quantities are within the prevailing market rates for road works

Procurement shall be based on the post qualification method and the above details will be submitted with the priced bid.

There shall be a **mandatory pre-tender site visits** as specified in the detailed tender notice above and as uploaded onto the KeNHA website.

**NOTE:**

**Every Bidder shall be represented by one Technical Person with a Minimum qualification of a Diploma in Civil/Highway Engineering. The Individual SHALL bring along the following in hard copies:**

1. **Original ID/Passport and a CERTIFIED Copy**
2. **CERTIFIED copy of Diploma/H. Dip./Degree Certificate**
3. **CERTIFIED Copy of Registration Certificate and proof of current subscription by Engineers Board of Kenya (EBK)/ Kenya Engineering Technology Registration Board (KETRB)/ Institute of Engineering Technologists and Technicians (IET)**
4. **Original Introductory letter bearing the Company letterhead and an Official Stamp authorizing them to represent them in the specific pre-tender site visit/Pre-Tender Conference. The letter shall be duly signed. Photocopies or any other media shall not be accepted.**
  - The copies of ID/Passport, Academic Certificates, Professional Registration Certificate, proof of current subscription **SHALL** be certified by commissioner of oaths or Notaries public
  - All the above documents shall be retained by the Procuring Entity's and may be verified later for authenticity.

**One (1) person shall only represent one (1) company per Tender.**

The detailed tender notice is available in the KeNHA website and Public Procurement Information Portal (PIIP). Clarifications and Questions may be sent to [procurement@kenha.co.ke](mailto:procurement@kenha.co.ke) as indicated in the Tender Notice.

**NOTE:**

1. **Every bidder shall make their own arrangements to familiarize themselves with the site conditions and the Road and its features.**
2. **Clarity on Serialization of Tender Documents by Prospective Bidders**  
**Please note that all pages of the tender documents submitted by bidders shall be sequentially serialized numerically that is; 1,2,3,4,5...etc. That is, serialization shall be undertaken by the bidder, by doing fresh numbering on its documents. The pagination of the tender documents as downloaded from the KeNHA website should not be used as a means of Serialization. The bidder's serialization should follow the same logical sequence from the first page to the end.**

Interested eligible candidates may obtain further information and inspect tender documents from the **Procurement Office, Kenya National Highways Authority, South Rift Regional Office** as indicated in the Tender Notice during normal working hours.

A complete set of tender documents may be obtained by interested tenderers from the Kenya National Highways Authority website: [www.kenha.co.ke](http://www.kenha.co.ke) or PIIP portal: [www.tenders.go.ke](http://www.tenders.go.ke) free of charge. Bidders are encouraged to download tender documents to minimise physical visits to the respective **KeNHA Regional Offices**.

Completed tender documents are to be enclosed in plain sealed envelope clearly marked with tender name, reference number and submitted to: -

**Office of the Regional Director – South Rift**

**Kenya National Highways Authority,**

**Public Works Building, Off Prison Road Nakuru**

**P. O. Box 17752-20100,**

**NAKURU, KENYA**

or

Or Deposited in the Tender Box at the reception area, **KeNHA South Rift Region 1st Floor, former Provincial Public Works Building, along Prison Road, Nakuru** so as to be received on or before **the Date and Time as indicated in the Tender Notice.**

**All interested bidders are required to continually check the Kenya National Highways Authority website: [www.kenha.co.ke](http://www.kenha.co.ke) for any tender addendums or clarifications that may arise before submission date.**

Tenders will be opened immediately thereafter in the presence of Tenderers/Representatives who wish to attend at the KeNHA South Rift Regional Office Board Room.

**Deputy Director, Supply Chain Management**

**For: DIRECTOR GENERAL**

---

**PART 1 TENDERING PROCEDURES**

---

## SECTION II - INSTRUCTIONS TO TENDERERS

### A. GENERAL PROVISIONS

#### 1. Scope of Tender

The Procuring Entity as defined in the Appendix to Conditions of Contract invites tenders for Works Contract as described in the tender documents. The name, identification, and number of lots (contracts) of this Tender Document are **specified in the TDS**.

#### 2. Fraud and Corruption

- 2.1 The Procuring Entity requires compliance with the provisions of the Public Procurement and Asset Disposal Act, 2015, Section 62 “Declaration not to engage in corruption”. The tender submitted by a person shall include a declaration that the person shall not engage in any corrupt or fraudulent practice and a declaration that the person or his or her sub-contractors are not debarred from participating in public procurement proceedings.
- 2.2 The Procuring Entity requires compliance with the provisions of the Competition Act 2010, regarding collusive practices in contracting. Any tenderer found to have engaged in collusive conduct shall be disqualified and criminal and/or civil sanctions may be imposed. To this effect, Tenders shall be required to complete and sign the “Certificate of Independent Tender Determination” annexed to the Form of Tender.
- 2.3 Tenderers shall permit and shall cause their agents (where declared or not), subcontractors, sub-consultants, service providers, suppliers, and their personnel, to permit the Procuring Entity to inspect all accounts, records and other documents relating to any initial selection process, pre-qualification process, tender submission, proposal submission, and contract performance (in the case of award), and to have them audited by auditors appointed by the Procuring Entity.
- 2.4 Unfair Competitive Advantage -Fairness and transparency in the tender process require that the firms or their Affiliates competing for a specific assignment do not derive a competitive advantage from having provided consulting services related to this tender. To that end, the Procuring Entity shall indicate in the **Data Sheet** and make available to all the firms together with this tender document all information that would in that respect give such firm any unfair competitive advantage over competing firms.

#### 3. Eligible Tenderers

- 3.1 A Tenderer may be a firm that is a private entity, a state-owned enterprise or institution subject to ITT 3.8, or an individual or any combination of such entities in the form of a joint venture (JV) under an existing agreement or with the intent to enter into such an agreement supported by a letter of intent. In the case of a joint venture, all members shall be jointly and severally liable for the execution of the entire Contract in accordance with the Contract terms. The JV shall nominate a Representative who shall have the authority to conduct all business for and on behalf of any and all the members of the JV during the tendering process and, in the event the JV is awarded the Contract, during contract execution. Members of a joint venture may not also make an individual tender, be a subcontractor in a separate tender or be part of another joint venture for the purposes of the same Tender. The maximum number of JV members shall be specified in the **TDS**.
- 3.2 Public Officers of the Procuring Entity, their Spouses, Child, Parent, Brothers or Sister. Child, Parent, Brother or Sister of a Spouse, their business associates or agents and firms/organizations in which they have a substantial or controlling interest shall not be eligible to tender or be awarded a contract. Public Officers are also not allowed to participate in any procurement proceedings.
- 3.3 A Tenderer shall not have a conflict of interest. Any tenderer found to have a conflict of interest shall be disqualified. A tenderer may be considered to have a conflict of interest for the purpose of this tendering process, if the tenderer:
  - a) Directly or indirectly controls, is controlled by or is under common control with another tenderer;

or

- b) Receives or has received any direct or indirect subsidy from another tenderer; or
  - c) Has the same legal representative as another tenderer; or
  - d) Has a relationship with another tenderer, directly or through common third parties, that puts it in a position to influence the tender of another tenderer, or influence the decisions of the Procuring Entity regarding this tendering process; or
  - e) Any of its affiliates participated as a consultant in the preparation of the design or technical specifications of the goods or works that are the subject of the tender; or
  - f) any of its affiliates has been hired (or is proposed to be hired) by the Procuring Entity as a consultant for Contract implementation; or
  - g) Would be providing goods, works, or non-consulting services resulting from or directly related to consulting services for the preparation or implementation of the contract specified in this Tender Document; or
  - h) Has a close business or personal relationship with senior management or professional staff of the Procuring Entity who has the ability to influence the bidding process and:
    - i) are directly or indirectly involved in the preparation of the Tender document or specifications of the Contract, and/or the Tender evaluation process of such contract; or
    - ii) May be involved in the implementation or supervision of such Contract unless the conflict stemming from such relationship has been resolved in a manner acceptable to the Procuring Entity throughout the tendering process and execution of the Contract.
- 34 A tenderer shall not be involved in corrupt, coercive, obstructive or fraudulent practice. A tenderer that is proven to have been involved in any of these practices shall be automatically disqualified.
- 35 A Tenderer (either individually or as a JV member) shall not participate in more than one Tender, except for permitted alternative tenders. This includes participation as a subcontractor in other Tenders. Such participation shall result in the disqualification of all Tenders in which the firm is involved. Members of a joint venture may not also make an individual tender, be a subcontractor in a separate tender or be part of another joint venture for the purposes of the same Tender. A firm that is not a tenderer or a JV member may participate as a subcontractor in more than one tender.
- 36 A Tenderer may have the nationality of any country, subject to the restrictions pursuant to ITT3.9. A Tenderer shall be deemed to have the nationality of a country if the Tenderer is constituted, incorporated or registered in and operates in conformity with the provisions of the laws of that country, as evidenced by its articles of incorporation (or equivalent documents of constitution or association) and its registration documents, as the case may be. This criterion also shall apply to the determination of the nationality of proposed subcontractors or sub-consultants for any part of the Contract including related Services.
- 37 A Tenderer that has been debarred from participating in public procurement shall be ineligible to tender or be awarded a contract. The list of debarred firms and individuals is available from the website of PPRA [www.ppra.go.ke](http://www.ppra.go.ke).
- 38 A Tenderer that is a state-owned enterprise or a public institution in Kenya may be eligible to tender and be awarded a Contract(s) only if it is determined by the Procuring Entity to meet the following conditions, i.e. if it is:
  - i) A legal public entity of Government and/or public administration,
  - ii) financially autonomous and not receiving any significant subsidies or budget support from any public entity or Government, and
  - iii) Operating under commercial law and vested with legal rights and liabilities similar to any commercial enterprise to enable it compete with firms in the private sector on an equal basis.
- 39 Firms and individuals shall be ineligible if their countries of origin are:
  - a) as a matter of law or official regulations, Kenya prohibits commercial relations with that country, or
  - b) by an act of compliance with a decision of the United Nations Security Council taken under Chapter VII of the Charter of the United Nations, Kenya prohibits any import of goods or

contracting of works or services from that country, or any payments to any country, person, or entity in that country.

A tenderer shall provide such documentary evidence of eligibility satisfactory to the Procuring Entity, as the Procuring Entity shall reasonably request.

- 3.10 Foreign tenderers are required to source at least forty (40%) percent of their contract inputs (in supplies, local subcontracts and labor) from citizen suppliers and contractors. To this end, a foreign tenderer shall provide in its tender documentary evidence that this requirement is met. Foreign tenderers not meeting this criterion will be automatically disqualified. Information required to enable the Procuring Entity determine if this condition is met shall be provided for this purpose in “*SECTION III-EVALUATION AND QUALIFICATION CRITERIA, Item 9*”.
- 3.11 Pursuant to the eligibility requirements of ITT4.10, a tender is considered a foreign tenderer, if the tenderer is not registered in Kenya or if the tenderer is registered in Kenya and has less than 51 percent ownership by Kenyan citizens. JVs are considered as foreign tenderers if the individual member firms are not registered in Kenya or if are registered in Kenya and have less than 51 percent ownership by Kenyan citizens. The JV shall not subcontract to foreign firms more than 10 percent of the contract price, excluding provisional sums.
- 3.12 The National Construction Authority Act of Kenya requires that all local and foreign contractors be registered with the National Construction Authority and be issued with a Registration Certificate before they can undertake any construction works in Kenya. Registration shall not be a condition for tender, but it shall be a condition of contract award and signature. A selected tenderer shall be given opportunity to register before such award and signature of contract. Application for registration with National Construction Authority may be accessed from the website [www.nca.go.ke](http://www.nca.go.ke).
- 3.13 The Competition Act of Kenya requires that firms wishing to tender as Joint Venture undertakings which may prevent, distort or lessen competition in provision of services are prohibited unless they are exempt in accordance with the provisions of Section 25 of the Competition Act, 2010. JVs will be required to seek for exemption from the Competition Authority. Exemption shall not be a condition for tender, but it shall be a condition of contract award and signature. A JV tenderer shall be given opportunity to seek such exemption as a condition of award and signature of contract. Application for exemption from the Competition Authority of Kenya may be accessed from the website [www.cak.go.ke](http://www.cak.go.ke).
- 4.14 A Kenyan tenderer shall be eligible to tender if it provides evidence of having fulfilled his/her tax obligations by producing a valid tax compliance or valid tax certificate issued by the Kenya Revenue Authority.

#### **4. Eligible Goods, Equipment, and Services**

- 4.1 Goods, equipment and services to be supplied under the Contract may have their origin in any country that is not ineligible under ITT3.9. At the Procuring Entity's request, Tenderers may be required to provide evidence of the origin of Goods, equipment and services.
- 4.2 Any goods, works and production processes with characteristics that have been declared by the relevant national environmental protection agency or by other competent authority as harmful to human beings and to the environment shall not be eligible for procurement.

#### **5. Tenderer's Responsibilities**

- 5.1 The tenderer shall bear all costs associated with the preparation and submission of his/her tender, and the Procuring Entity will in no case be responsible or liable for those costs.
- 5.2 The tenderer, at the tenderer's own responsibility and risk, is encouraged to visit and examine and inspect the Site of the Works and its surroundings and obtain all information that may be necessary for preparing the tender and entering into a contract for construction of the Works. The costs of visiting the Site shall be at the tenderer's own expense.

- 53 The Tenderer and any of its personnel or agents will be granted permission by the Procuring Entity to enter up on its premises and lands for the purpose of such visit. The Tenderer shall indemnify the Procuring Entity against all liability arising from death or personal injury, loss of or damage to property, and any other losses and expenses incurred as a result of the examination and inspection.
- 54 The tenderer shall provide in the Form of Tender and Qualification Information, a preliminary description of the proposed work method and schedule, including charts, as necessary or required.

## **B. CONTENTS OF TENDER DOCUMENTS**

### **6 Sections of Tender Document**

- 6.1 The tender document consists of Parts 1, 2, and 3, which includes all the sections specified below, and which should be read in conjunction with any Addenda issued in accordance with ITT10.

#### **PART 1: Tendering**

##### **Procedures** Section I:

Instructions to Tenderers

Section II: Tender Data Sheet  
(TDS)

Section III: Evaluation and Qualification

Criteria Section IV: Tendering Forms

#### **PART 2: Works'**

##### **Requirements** Section V:

Bills of Quantities Section

VI: Specifications Section

VII: Drawings

#### **PART3: Conditions of Contract and Contract**

**Forms** Section VIII: General Conditions

(GCC) Section IX: Particular Conditions of

Contract Section X: Contract Forms

- 62 The Invitation to Tender Notice issued by the Procuring Entity is not part of the Contract documents.
- 63 Unless obtained directly from the Procuring Entity, the Procuring Entity is not responsible for the completeness of the Tender document, responses to requests for clarification, the minutes of a pre-arranged site visit and those of the pre-Tender meeting (if any), or Addenda to the Tender document in accordance with ITT 10. In case of any contradiction, documents obtained directly from the Procuring Entity shall prevail.
- 64 The Tenderer is expected to examine all instructions, forms, terms, and specifications in the Tender Document and to furnish with its Tender all information and documentation as is required by the Tender document.

### **7. Clarification of Tender Document, Site Visit, Pre-Tender Meeting**

- 7.1 Tenderer requiring any clarification of the Tender Document shall contact the Procuring Entity in writing at the Procuring Entity's address **specified in the TDS** or raise its enquiries during the pre-Tender meeting if provided for in accordance with ITT 7.2. The Procuring Entity will respond in writing to any request for clarification, provided that such request is received no later than the period specified in the **TDS** prior to the deadline for submission of tenders. The Procuring Entity shall forward copies of its response to all tenderers who have acquired the Tender D documents in accordance with ITT 7.4, including a description of the inquiry but without identifying its source. If so specified **in the TDS**, the Procuring Entity shall also promptly publish its response at the web page identified in the **TDS**. Should the clarification result in changes to the essential elements of the Tender Documents, the Procuring Entity shall amend the Tender Documents following the procedure under ITT 8 and ITT

22.2.

- 72 The Tenderer, at the Tenderer's own responsibility and risk, is encouraged to visit and examine and inspect the site(s) of the required contracts and obtain all information that may be necessary for preparing a tender. The costs of visiting the Site shall be at the Tenderer's own expense. The Procuring Entity shall specify in the **TDS** if a pre-arranged Site visit and or a pre-tender meeting will be held, when and where. The Tenderer's designated representative is invited to attend a pre-arranged site visit and a pre-tender meeting, as the case may be. The purpose of the site visit and the pre-tender meeting will be to clarify issues and to answer questions on any matter that may be raised at that stage.
- 73 The Tenderer is requested to submit any questions in writing, to reach the Procuring Entity not later than the period specified in the **TDS** before the meeting.
- 74 Minutes of a pre-arranged site visit and those of the pre-tender meeting, if applicable, including the text of the questions asked by Tenderers and the responses given, together with any responses prepared after the meeting, will be transmitted promptly to all Tenderers who have acquired the Tender Documents. Minutes shall not identify the source of the questions asked.
- 75 The Procuring Entity shall also promptly publish anonymized (*no names*) Minutes of the pre-arranged site visit and those of the pre-tender meeting at the web page identified **in the TDS**. Any modification to the Tender Documents that may become necessary as a result of the pre-arranged site visit and those of the pre-tender meeting shall be made by the Procuring Entity exclusively through the issue of an Addendum pursuant to ITT 8 and not through the minutes of the pre-Tender meeting. Non-attendance at the pre-arranged site visit and the pre-tender meeting will not be a cause for disqualification of a Tenderer.

## **8 Amendment of Tender Documents**

- 81 At any time prior to the deadline for submission of Tenders, the Procuring Entity may amend the Tender Documents by issuing addenda.
- 82 Any addendum issued shall be part of the Tender Documents and shall be communicated in writing to all who have obtained the Tender Documents from the Procuring Entity. The Procuring Entity shall also promptly publish the addendum on the Procuring Entity's website in accordance with ITT 7.5.
- 83 To give Tenderers reasonable time in which to take an addendum into account in preparing their Tenders, the Procuring Entity should extend the deadline for the submission of Tenders, pursuant to ITT 22.2.

## **C. PREPARATION OF TENDERS**

### **9 Cost of Tendering**

The Tenderer shall meet all costs associated with the preparation and submission of its Tender, and the Procuring Entity shall not be responsible or liable for those costs, regardless of the conduct or outcome of the tendering process.

### **10 Language of Tender**

The Tender, as well as all correspondence and documents relating to the tender exchanged by the tenderer and the Procuring Entity, shall be written in the English Language. Supporting documents and printed literature that are part of the Tender may be in another language provided they are accompanied by an accurate and notarized translation of the relevant passages into the English Language, in which case, for purposes of interpretation of the Tender, such translation shall govern.

### **11 Documents Comprising the Tender**

- 11.1 The Tender shall comprise the following:
  - a) Form of Tender prepared in accordance with ITT 12;

- b) Schedules including priced Bill of Quantities, completed in accordance with ITT 12 and ITT 14;
- c) Tender Security or Tender-Securing Declaration, in accordance with ITT 19.1;
- d) Alternative Tender, if permissible, in accordance with ITT 13;
- e) Authorization: written confirmation authorizing the signatory of the Tender to commit the Tenderer, in accordance with ITT 20.3;
- f) Qualifications: documentary evidence in accordance with ITT 17 establishing the Tenderer's qualifications to perform the Contract if its Tender is accepted;
- g) Conformity: a technical proposal in accordance with ITT 16;
- h) Any other document required in the TDS.

11.2 In addition to the requirements under ITT 11.1, Tenders submitted by a JV shall include a copy of the Joint Venture Agreement entered into by all members. Alternatively, a letter of intent to execute a Joint Venture Agreement in the event of a successful Tender shall be signed by all members and submitted with the Tender, together with a copy of the proposed JV Agreement. Change of membership and conditions of the JV prior to contract signature will render the tender liable for disqualification.

## **12. Form of Tender and Schedules**

12.1 The Form of Tender and Schedules, including the Bill of Quantities, shall be prepared using the relevant forms furnished in Section IV, Tendering Forms. The forms must be completed without any alterations to the text, and no substitutes shall be accepted except as provided under ITT 20.3. All blank spaces shall be filled in with the information requested. The Tenderer shall chronologically serialize all pages of the tender documents submitted.

12.2 The Tenderer shall furnish in the Form of Tender information on commissions and gratuities, if any, paid or to be paid to agents or any other party relating to this Tender.

## **13. Alternative Tenders**

13.1 Unless otherwise specified in the TDS, alternative Tenders shall not be considered.

13.2 When alternative times for completion are explicitly invited, a statement to that effect will be included in the **TDS**, and the method of evaluating different alternative times for completion will be described in Section III, Evaluation and Qualification Criteria.

13.3 Except as provided under ITT13.4 below, Tenderers wishing to offer technical alternatives to the requirements of the Tender Documents must first price the Procuring Entity's design as described in the Tender Documents and shall further provide all information necessary for a complete evaluation of the alternative by the Procuring Entity, including drawings, design calculations, technical specifications, breakdown of prices, and proposed construction methodology and other relevant details. Only the technical alternatives, if any, of the Tenderer with the Winning Tender conforming to the basic technical requirements shall be considered by the Procuring Entity.

13.4 When specified in the **TDS**, Tenderers are permitted to submit alternative technical solutions for specified parts of the Works, and such parts will be identified in the **TDS**, as will the method for their evaluating, and described in Section VII, Works' Requirements.

## **14. Tender Prices and Discounts**

14.1 The prices and discounts (including any price reduction) quoted by the Tenderer in the Form of Tender and in the Bill of Quantities shall conform to the requirements specified below.

14.2 The Tenderer shall fill in rates and prices for all items of the Works described in the Bill of Quantities. Items against which no rate or price is entered by the Tenderer shall be deemed covered by the rates for other items in the Bill of Quantities and will not be paid for separately by the Procuring Entity. An item not listed in the priced Bill of Quantities shall be assumed to be not included in the Tender, and provided that the Tender is determined substantially responsive notwithstanding this omission, the average price of the item quoted by substantially responsive Tenderers will be added to the Tender

price and the equivalent total cost of the Tender so determined will be used for price comparison.

- 14.3 The price to be quoted in the Form of Tender, in accordance with ITT 12, shall be the total price of the Tender, including any discounts offered.
- 14.4 The Tenderer shall quote any discounts and the methodology for their application in the Form of Tender, in accordance with ITT 12
- 14.5 It will be specified in the **TDS** if the rates and prices quoted by the Tenderer are or are not subject to adjustment during the performance of the Contract in accordance with the provisions of the Conditions of Contract, excepting cases where the contract is subject to fluctuations and adjustments, not fixed price. In such a case, the Tenderer shall furnish the indices and weightings for the price adjustment formulae in the Schedule of Adjustment Data and the Procuring Entity may require the Tenderer to justify its proposed indices and weightings.
- 14.6 Where tenders are being invited for individual lots (contracts) or for any combination of lots (packages), tenderers wishing to offer discounts for the award of more than one Contract shall specify in their Tender the price reductions applicable to each package, or alternatively, to individual Contracts within the package. Discounts shall be submitted in accordance with ITT 14.4, provided the Tenders for all lots (contracts) are opened at the same time.
- 14.7 All duties, taxes, and other levies payable by the Contractor under the Contract, or for any other cause, as of the date 30 days prior to the deadline for submission of Tenders, shall be included in the rates and prices and the total Tender Price submitted by the Tenderer.

## **15. Currencies of Tender and Payment**

- 15.1 The currency (ies) of the Tender and the currency (ies) of payments shall be the same.
- 15.2 Tenderers shall quote entirely in Kenya Shillings. The unit rates and the prices shall be quoted by the Tenderer in the Bill of Quantities, entirely in Kenya shillings
  - a) A Tenderer expecting to incur expenditures in other currencies for inputs to the Works supplied from outside Kenya (referred to as “the foreign currency requirements”) shall (if so allowed in the **TDS**) indicate in the Appendix to Tender the percentage(s) of the Tender Price (excluding Provisional Sums), needed by the Tenderer for the payment of such foreign currency requirements, limited to no more than two foreign currencies.
  - b) The rates of exchange to be used by the Tenderer in arriving at the local currency equivalent and the percentage(s) mentioned in (a) above shall be specified by the Tenderer in the Appendix to Tender and shall be based on the exchange rate provided by the Central Bank of Kenya on the date 30 days prior to the actual date of tender opening. Such exchange rate shall apply for all foreign payments under the Contract.
- 15.3 Tenderers may be required by the Procuring Entity to justify, to the Procuring Entity's satisfaction, their local and foreign currency requirements, and to substantiate that the amounts included in the unit rates and prices and shown in the Schedule of Adjustment Data in the Appendix to Tender are reasonable, in which case a detailed breakdown of the foreign currency requirements shall be provided by Tenderers.

## **16. Documents Comprising the Technical Proposal**

The Tenderer shall furnish a technical proposal including a statement of work methods, equipment, personnel, schedule and any other information as stipulated in Section IV, Tender Forms, insufficient detail to demonstrate the adequacy of the Tenderer's proposal to meet the work's requirements and the completion time.

## **17. Documents Establishing the Eligibility and Qualifications of the Tenderer**

- 17.1 Tenderers shall complete the Form of Tender, included in Section IV, Tender Forms, to establish Tenderer's eligibility in accordance with ITT 4.

- 17.2 In accordance with Section III, Evaluation and Qualification Criteria, to establish its qualifications to perform the Contract the Tenderer shall provide the information requested in the corresponding information sheets included in Section IV, Tender Forms.
- 17.3 If a margin of preference applies as specified in accordance with ITT33. 1, national tenderers, individually or in joint ventures, applying for eligibility for national preference shall supply all information required to satisfy the criteria for eligibility specified in accordance with ITT 33.1.
- 17.4 Tenderers shall be asked to provide, as part of the data for qualification, such information, including details of ownership, as shall be required to determine whether, according to the classification established by the Procuring Entity, a particular contract or group of contractors qualifies for a margin of preference. Further the information will enable the Procuring Entity identify any actual or potential conflict of interest in relation to the procurement and/or contract management processes, or possibility of collusion between tenderers, and there by help to prevent any corrupt influence in relation to the procurement process or contract management.
- 17.5 The purpose of the information described in **ITT 17.2** above overrides any claims to confidentiality which a tenderer may have. There can be no circumstances in which it would be justified for a tenderer to keep information relating to its ownership and control confidential where it is tendering to undertake public sector work and receive public sector funds. Thus, confidentiality will not be accepted by the Procuring Entity as a justification for a Tenderer's failure to disclose, or failure to provide required information on its ownership and control.
- 17.6 The Tenderer shall provide further documentary proof, information or authorizations that the Procuring Entity may request in relation to ownership and control which information on any changes to the information which was provided by the tenderer under ITT 6.4. The obligations to require this information shall continue for the duration of the procurement process and contract performance and after completion of the contract, if any change to the information previously provided may reveal a conflict of interest in relation to the award or management of the contract.
- 17.7 All information provided by the tenderer pursuant to these requirements must be complete, current and accurate as at the date of provision to the Procuring Entity. In submitting the information required pursuant to these requirements, the Tenderer shall warrant that the information submitted is complete, current and accurate as at the date of submission to the Procuring Entity.
- 17.8 If a tenderer fails to submit the information required by these requirements, its tenderer will be rejected. Similarly, if the Procuring Entity is unable, after taking reasonable steps, to verify to a reasonable degree the information submitted by a tenderer pursuant to these requirements, then the tender will be rejected.
- 17.9 If information submitted by a tenderer pursuant to these requirements, or obtained by the Procuring Entity (whether through its own enquiries, through notification by the public or otherwise), shows any conflict of interest which could materially and improperly benefit the tenderer in relation to the procurement or contract management process, then:
- i) If the procurement process is still on going, the tenderer will be disqualified from the procurement process,
  - ii) If the contract has been awarded to that tenderer, the contract award will be set aside,
  - iii) the tenderer will be referred to the relevant law enforcement authorities for investigation of whether the tenderer or any other persons have committed any criminal offence.
- 17.10 If a tenderer submits information pursuant to these requirements that is incomplete, inaccurate or out-of-date, or attempts to obstruct the verification process, then the consequences ITT 17.8 will ensue unless the tenderer can show to the reasonable satisfaction of the Procuring Entity that any such act was not material, or was due to genuine error which was not attributable to the intentional act, negligence or recklessness of the tender.

## **18. Period of Validity of Tenders**

- 18.1.** Tenders shall remain valid for the Tender Validity period specified in the **TDS**. The Tender Validity period starts from the date fixed for the Tender submission deadline (as prescribed by the Procuring Entity in accordance with ITT 22). A Tender valid for a shorter period shall be rejected by the Procuring Entity as non-responsive.

18.2 In exceptional circumstances, prior to the expiration of the Tender validity period, the Procuring Entity may request Tenderers to extend the period of validity of their Tenders. The request and the responses shall be made in writing. If a Tender Security is requested in accordance with ITT 19, it shall also be extended for thirty (30) days beyond the deadline of the extended validity period. A Tenderer may refuse the request without forfeiting its Tender security. A Tenderer granting their quest shall not be required or permitted to modify its Tender.

## **19. Tender Security**

19.1 The Tenderer shall furnish as part of its Tender, either a Tender-Securing Declaration or a Tender Security as specified in the **TDS**, in original form and, in the case of a Tender Security, in the amount and currency **specified in the TDS**. A Tender-Securing Declaration shall use the form included in Section IV, Tender Forms.

19.2 If a Tender Security is specified pursuant to ITT 19.1, the Tender Security shall be a demand guarantee in any of the following forms at the Tenderer's option:

- i) cash;
- ii) a bank guarantee;
- iii) a guarantee by an insurance company registered and licensed by the Insurance Regulatory Authority listed by the Authority; or
- iv) a guarantee issued by a financial institution approved and licensed by the Central Bank of Kenya, from a reputable source, and an eligible country.

19.3 If an unconditional bank guarantee is issued by a bank located outside Kenya, the issuing bank shall have a correspondent bank located in Kenya to make it enforceable. The Tender Security shall be valid for thirty (30) days beyond the original validity period of the Tender, or beyond any period of extension if requested under ITT 18.2.

19.4 If a Tender Security or Tender-Securing Declaration is specified pursuant to ITT 19.1, any Tender not accompanied by a substantially responsive Tender Security or Tender-Securing Declaration shall be rejected by the Procuring Entity as non-responsive.

19.5 If a Tender Security is specified pursuant to ITT 19.1, the Tender Security of unsuccessful Tenderers shall be returned as promptly as possible upon the successful Tenderer's signing the Contract and furnishing the Performance Security and any other documents required in the TDS. The Procuring Entity shall also promptly return the tender security to the tenderers where the procurement proceedings are terminated, all tenders were determined non-responsive or a bidder declines to extend tender validity period.

19.6 The Tender Security of the successful Tenderer shall be returned as promptly as possible once the successful Tenderer has signed the Contract and furnished the required Performance Security, and any other documents required in the TDS.

19.7 The Tender Security may be forfeited or the Tender-Securing Declaration executed:

- a) if a Tenderer withdraws its Tender during the period of Tender validity specified by the Tenderer on the Form of Tender, or any extension there to provided by the Tenderer; or
- b) if the successful Tenderer fails to:
  - i) sign the Contract in accordance with ITT 47; or
  - ii) furnish a Performance Security and if required in the TDS, and any other documents required in the TDS.

19.8 Where tender securing declaration is executed, the Procuring Entity shall recommend to the PPRA that PPRA debars the Tenderer from participating in public procurement as provided in the law.

19.9 The Tender Security or the Tender-Securing Declaration of a JV shall be in the name of the JV that submits the Tender. If the JV has not been legally constituted into a legally enforceable JV at the time of tendering, the Tender Security or the Tender-Securing Declaration shall be in the names of all future members as named in the letter of intent referred to in ITT 4.1 and ITT 11.2.

19.10 A tenderer shall not issue a tender security to guarantee itself.

## **20. Format and Signing of Tender**

- 20.1 The Tenderer shall prepare one original of the documents comprising the Tender as described in ITT 11 and clearly mark it “ORIGINAL.” Alternative Tenders, if permitted in accordance with ITT 13, shall be clearly marked “ALTERNATIVE.” In addition, the Tenderer shall submit copies of the Tender, in the number **specified in the TDS** and clearly mark them “COPY.” In the event of any discrepancy between the original and the copies, the original shall prevail.
- 20.2 Tenderers shall mark as “CONFIDENTIAL” all information in their Tenders which is confidential to their business. This may include proprietary information, trade secrets, or commercial or financially sensitive information.
- 20.3 The original and all copies of the Tender shall be typed or written in indelible ink and shall be signed by a person duly authorized to sign on behalf of the Tenderer. This authorization shall consist of a written confirmation as specified in the **TDS** and shall be attached to the Tender. The name and position held by each person signing the authorization must be typed or printed below the signature. All pages of the Tender where entries or amendments have been made shall be signed or initialed by the person signing the Tender.
- 20.4 In case the Tenderer is a JV, the Tender shall be signed by an authorized representative of the JV on behalf of the JV, and so as to be legally binding on all the members as evidenced by a power of attorney signed by their legally authorized representatives.
- 20.5 Any inter-lineation, erasures, or overwriting shall be valid only if they are signed or initialed by the person signing the Tender.

## **D. SUBMISSION AND OPENING OF TENDERS**

### **21. Sealing and Marking of Tenders**

- 21.1 The Tenderer shall deliver the Tender in a single sealed envelope, or in a single sealed package, or in a single sealed container bearing the name and Reference number of the Tender, addressed to the Procuring Entity and a warning not to open before the time and date for Tender opening date. Within the single envelope, package or container, the Tenderer shall place the following separate, sealed envelopes:
  - a) in an envelope or package or container marked “ORIGINAL”, all documents comprising the Tender, as described in ITT 11; and
  - b) in an envelope or package or container marked “COPIES” all required copies of the Tender; and
  - c) if alternative Tenders are permitted in accordance with ITT 13, and if relevant:
    - i) in an envelope or package or container marked “ORIGINAL - ALTERNATIVE TENDER”, the alternative Tender; and
    - ii) in the envelope or package or container marked “COPIES-ALTERNATIVE TENDER”, all required copies of the alternative Tender.

The inner envelopes or packages or containers shall:

- a) bear the name and address of the Procuring Entity.
  - b) Bear the name and address of the Tenderer; and
  - c) Bear the name and Reference number of the Tender.
- 21.2 If an envelope or package or container is not sealed and marked as required, the *Procuring Entity* will assume no responsibility for the misplacement or premature opening of the Tender. Tenders that were misplaced or opened prematurely will not be accepted.

### **22. Deadline for Submission of Tenders**

- 22.1 Tenders must be received by the Procuring Entity at the address specified in the **TDS** and no later

than the date and time also specified in the **TDS**. When so specified in the **TDS**, Tenderers shall have the option of submitting their Tenders electronically. Tenderers submitting Tenders electronically shall follow the electronic Tender submission procedures specified in the **TDS**.

22.2 The Procuring Entity may, at its discretion, extend the deadline for the submission of Tenders by amending the Tender Documents in accordance with ITT 8, in which case all rights and obligations of the Procuring Entity and Tenderers previously subject to the deadline shall thereafter be subject to the deadline as extended.

### **23. Late Tenders**

The Procuring Entity shall not consider any Tender that arrives after the deadline for submission of tenders, in accordance with ITT 22. Any Tender received by the Procuring Entity after the deadline for submission of Tenders shall be declared late, rejected, and returned unopened to the Tenderer.

### **24. Withdrawal, Substitution, and Modification of Tenders**

24.1 A Tenderer may withdraw, substitute, or modify its Tender after it has been submitted by sending a written notice, duly signed by an authorized representative, and shall include a copy of the authorization in accordance with ITT 20.3, (except that withdrawal notices do not require copies). The corresponding substitution or modification of the Tender must accompany the respective written notice. All notices must be:

- a) prepared and submitted in accordance with ITT 20 and ITT 21 (except that withdrawals notices do not require copies), and in addition, the respective envelopes shall be clearly marked “WITHDRAWAL,” “SUBSTITUTION,” “MODIFICATION;” and
- b) received by the Procuring Entity prior to the deadline prescribed for submission of Tenders, in accordance with ITT 22.

24.2 Tenders requested to be withdrawn in accordance with ITT 24.1 shall be returned unopened to the Tenderers.

24.3 No Tender may be withdrawn, substituted, or modified in the interval between the deadline for submission of Tenders and the expiration of the period of Tender validity specified by the Tenderer on the Form of Tender or any extension thereof.

### **25. Tender Opening**

25.1 Except in the cases specified in ITT 23 and ITT 24.2, the Procuring Entity shall publicly open and read out all Tenders received by the deadline, at the date, time and place specified **in the TDS**, in the presence of Tenderers' designated representatives and anyone who chooses to attend. Any specific electronic Tender opening procedures required if electronic Tendering is permitted in accordance with ITT 22.1, shall be as specified in the **TDS**.

25.2 First, envelopes marked “WITHDRAWAL” shall be opened and read out and the envelopes with the corresponding Tender shall not be opened but returned to the Tenderer. No Tender withdrawal shall be permitted unless the corresponding withdrawal notice contains a valid authorization to request the withdrawal and is read out at tender opening.

25.3 Next, envelopes marked “SUBSTITUTION” shall be opened and read out and exchanged with the corresponding Tender being substituted, and the substituted Tender shall not be opened, but returned to the Tenderer. No Tender substitution shall be permitted unless the corresponding substitution notice contains a valid authorization to request the substitution and is read out at Tender opening.

- 25.4 Next, envelopes marked "MODIFICATION" shall be opened and read out with the corresponding Tender No. Tender modification shall be permitted unless the corresponding modification notice contains a valid authorization to request the modification and is read out at Tender opening.
- 25.5 Next, all remaining envelopes shall be opened at the same time, reading out: the name of the Tenderer and whether there is a modification; the total Tender Price, per lot (contract) if applicable, including any discounts and alternative Tenders; the presence or absence of a Tender Security or Tender-Securing Declaration, if required; and any other details as the Procuring Entity may consider appropriate.
- 25.6 Only Tenders, alternative Tenders and discounts that are opened and read out at Tender opening shall be considered further for evaluation. The Form of Tender and pages of the Bill of Quantities (to be decided on by the tender opening committee) are to be initialed by the members of the tender opening committee attending the opening.
- 25.7 At the Tender Opening, the Procuring Entity shall neither discuss the merits of any Tender nor reject any Tender (except for late Tenders, in accordance with ITT 23.1).
- 25.8 The Procuring Entity shall prepare minutes of the Tender Opening that shall include, as a minimum:
- a) The name of the Tenderer and whether there is a withdrawal, substitution, or modification;
  - b) The Tender Price, per lot (contract) if applicable, including any discounts;
  - c) any alternative Tenders;
  - d) the presence or absence of a Tender Security, if one was required.
  - e) number of pages of each tender document submitted.
- 25.9 The Tenderers' representatives who are present shall be requested to sign the minutes. The omission of a Tenderer's signature on the minutes shall not invalidate the contents and effect of the minutes. A copy of tender opening register shall be issued to a tenderer upon request.

## **E. Evaluation and Comparison of Tenders**

### **26. Confidentiality**

- 26.1 Information relating to the evaluation of Tenders and recommendation of contract award shall not be disclosed to Tenderers or any other persons not officially concerned with the Tender process until information on Intention to Award the Contract is transmitted to all Tenderers in accordance with ITT 43.
- 26.2 Any effort by a Tenderer to influence the Procuring Entity in the evaluation of the Tenders or Contract award decisions may result in the rejection of its tender.
- 26.3 Notwithstanding ITT 26.2, from the time of tender opening to the time of contract award, if a tenderer wishes to contact the Procuring Entity on any matter related to the tendering process, it shall do so in writing.

### **27. Clarification of Tenders**

- 27.1 To assist in the examination, evaluation, and comparison of the tenders, and qualification of the tenderers, the Procuring Entity may, at its discretion, ask any tenderer for a clarification of its tender, given a reasonable time for a response. Any clarification submitted by a tenderer that is not in response to a request by the Procuring Entity shall not be considered. The Procuring Entity's request for clarification and the response shall be in writing. No change, including any voluntary increase or decrease, in the prices or substance of the tender shall be sought, offered, or permitted, except to confirm the correction of arithmetic errors discovered by the Procuring Entity in the evaluation of the tenders, in accordance with ITT 31.
- 27.2 If a tenderer does not provide clarifications of its tender by the date and time set in the Procuring

Entity's request for clarification, its Tender may be rejected.

## **28. Deviations, Reservations, and Omissions**

28.1 During the evaluation of tenders, the following definitions apply:

- a) "Deviation" is a departure from the requirements specified in the tender document;
- b) "Reservation" is the setting of limiting conditions or withholding from complete acceptance of the requirements specified in the tender document; and
- c) "Omission" is the failure to submit part or all of the information or documentation required in the Tender document.

## **29. Determination of Responsiveness**

29.1 The Procuring Entity's determination of a Tender's responsiveness is to be based on the contents of the tender itself, as defined in ITT 11.

29.2 A substantially responsive Tender is one that meets the requirements of the Tender document without material deviation, reservation, or omission. A material deviation, reservation, or omission is one that, if accepted, would:

- a) Affect in any substantial way the scope, quality, or performance of the Works specified in the Contract; or
- b) limit in any substantial way, inconsistent with the tender document, the Procuring Entity's rights or the tenderer's obligations under the proposed contract; or
- c) if rectified, would unfairly affect the competitive position of other tenderers presenting substantially responsive tenders.

29.3 The Procuring Entity shall examine the technical aspects of the tender submitted in accordance with ITT 16, to confirm that all requirements of Section VII, Works' Requirements have been met without any material deviation, reservation or omission.

29.4 If a tender is not substantially responsive to the requirements of the tender document, it shall be rejected by the Procuring Entity and may not subsequently be made responsive by correction of the material deviation, reservation, or omission.

## **30. Non-material Non-conformities**

30.1 Provided that a tender is substantially responsive, the Procuring Entity may waive any non-conformities in the tender.

30.2 Provided that a Tender is substantially responsive, the Procuring Entity may request that the tenderer submit the necessary information or documentation, within a reasonable period of time, to rectify nonmaterial non- conformities in the tender related to documentation requirements. Requesting information or documentation on such non-conformities shall not be related to any aspect of the price of the tender. Failure of the tenderer to comply with the request may result in the rejection of its tender.

30.3 Provided that a tender is substantially responsive, the Procuring Entity shall rectify quantifiable nonmaterial non-conformities related to the Tender Price. To this effect, the Tender Price shall be adjusted, for comparison purposes only, to reflect the price of a missing or non-conforming item or component in the manner specified **in the TDS**.

## **31. Arithmetical Errors**

31.1 The tender sum as submitted and read out during the tender opening shall be absolute and final and shall not be the subject of correction, adjustment or amendment in anyway by any person or entity.

31.2 Provided that the Tender is substantially responsive, the Procuring Entity shall handle errors on the

following basis:

- a) Any error detected if considered a major deviation that affects the substance of the tender, shall lead to disqualification of the tender as non-responsive.
- b) Any errors in the submitted tender arising from a miscalculation of unit price, quantity, sub total and total bid price shall be considered as a major deviation that affects the substance of the tender and shall lead to disqualification of the tender as non-responsive. and
- c) If there is a discrepancy between words and figures, the amount in words shall prevail

31.3 Tenderers shall be notified of any error detected in their bid during the notification of award.

### **32. Conversion to Single Currency**

For evaluation and comparison purposes, the currency (ies) of the Tender shall be converted into a single currency **as specified in the TDS**.

### **33. Margin of Preference and Reservations**

33.1 A margin of preference may be allowed only when the contract is open to international competitive tendering where foreign contractors are expected to participate in the tendering process and where the contract exceeds the value/threshold specified in the Regulations.

33.2 A margin of preference shall not be allowed unless it is specified so in the **TDS**.

33.3 Contracts procured on basis of international competitive tendering shall not be subject to reservations exclusive to specific groups as provided in ITT 33.4.

33.4 Where it is intended to reserve a contract to a specific group of businesses (these groups are Small and Medium Enterprises, Women Enterprises, Youth Enterprises and Enterprises of persons living with disability, as the case may be), and who are appropriately registered as such by the authority to be specified in the **TDS**, a procuring entity shall ensure that the invitation to tender specifically indicates that only businesses or firms belonging to the specified group are eligible to tender. No tender shall be reserved to more than one group. If not so stated in the Invitation to Tender and in the Tender documents, the invitation to tender will be open to all interested tenderers.

### **34. Nominated Subcontractors**

34.1 **Unless** otherwise stated **in the TDS**, the Procuring Entity does not intend to execute any specific elements of the Works by subcontractors selected/nominated by the Procuring Entity. In case the Procuring Entity nominates a subcontractor, the subcontract agreement shall be signed by the Subcontractor and the Procuring Entity. The main contract shall specify the working arrangements between the main contractor and the nominated subcontractor.

34.2 Tenderers may propose subcontracting upto the percentage of total value of contracts or the volume of works as specified **in the TDS**. Subcontractors proposed by the Tenderer shall be fully qualified for their parts of the Works.

34.3 Domestic subcontractor's qualifications shall not be used by the Tenderer to qualify for the Works unless their specialized parts of the Works were previously designated so by the Procuring Entity **in the TDS** as can be met by subcontractors referred to hereafter as 'Specialized Subcontractors', in which case, the qualifications of the Specialized Subcontractors proposed by the Tenderer may be added to the qualifications of the Tenderer.

### **35. Evaluation of Tenders**

35.1 The Procuring Entity shall use the criteria and methodologies listed in this ITT and Section III, Evaluation and Qualification Criteria. No other evaluation criteria or methodologies shall be permitted. By applying the criteria and methodologies the Procuring Entity shall determine the Lowest Evaluated Tender in accordance with ITT 40.

- 35.2 To evaluate a Tender, the Procuring Entity shall consider the following:
- a) Price adjustment in accordance with ITT 31.1(iii); excluding provisional sums and contingencies, if any, but including Day work items, where priced competitively;
  - b) Price adjustment due to discounts offered in accordance with ITT 14.4;
  - c) converting the amount resulting from applying (a) and (b) above, if relevant, to a single currency in accordance with ITT 32;
  - d) price adjustment due to quantifiable non-material non-conformities in accordance with ITT 30.3; and
  - e) any additional evaluation factors specified **in the TDS** and Section III, Evaluation and Qualification Criteria.
- 35.3 The estimated effect of the price adjustment provisions of the Conditions of Contract, applied over the period of execution of the Contract, shall not be considered intender evaluation.
- 35.4 Where the tender involves multiple lots or contracts, the tenderer will be allowed to tender for one or more lots (contracts). Each lot or contract will be evaluated in accordance with ITT 35.2. The methodology to determine the lowest evaluated tenderer or tenderers based one lot (contract) or based on a combination of lots (contracts), will be specified in Section III, Evaluation and Qualification Criteria. In the case of multiple lots or contracts, tenderer will be will be required to prepare the Eligibility and Qualification Criteria Form for each Lot.

### **36. Comparison of Tenders**

The Procuring Entity shall compare the evaluated costs of all substantially responsive Tenders established in accordance with ITT 35.2 to determine the Tender that has the lowest evaluated cost.

### **37. Abnormally Low Tenders and Abnormally High**

#### **Tenders Abnormally Low Tenders**

- 37.1 An Abnormally Low Tender is one where the Tender price, in combination with other elements of the Tender, appears so low that it raises material concerns as to the capability of the Tenderer in regards to the Tenderer's ability to perform the Contract for the offered Tender Price or that genuine competition between Tenderers is compromised.
- 37.2 In the event of identification of a potentially Abnormally Low Tender, the Procuring Entity shall seek written clarifications from the Tenderer, including detailed price analyses of its Tender price in relation to the subject matter of the contract, scope, proposed methodology, schedule, allocation of risks and responsibilities and any other requirements of the Tender document.
- 37.3 After evaluation of the price analyses, in the event that the Procuring Entity determines that the Tenderer has failed to demonstrate its capability to perform the Contract for the offered Tender Price, the Procuring Entity shall reject the Tender.

#### **Abnormally High Tenders**

- 37.4 An abnormally high tender price is one where the tender price, in combination with other constituent elements of the Tender, appears unreasonably too high to the extent that the Procuring Entity is concerned that it (the Procuring Entity) may not be getting value for money or it may be paying too high a price for the contract compared with market prices or that genuine competition between Tenderers is compromised.
- 37.5 In case of an abnormally high price, the Procuring Entity shall make a survey of the market prices, check if the estimated cost of the contract is correct and review the Tender Documents to check if the specifications, scope of work and conditions of contract are contributory to the abnormally high tenders. The Procuring Entity may also seek written clarification from the tenderer on the reason for the high tender price. The Procuring Entity shall proceed as follows:
- i) If the tender price is abnormally high based on wrong estimated cost of the contract, the

Procuring Entity may accept or not accept the tender depending on the Procuring Entity's budget considerations.

- ii) If specifications, scope of work and/or conditions of contract are contributory to the abnormally high tender prices, the Procuring Entity shall reject all tenders and may retender for the contract based on revised estimates, specifications, scope of work and conditions of contract, as the case may be.

37.6 If the Procuring Entity determines that the Tender Price is abnormally too high because genuine competition between tenderers is compromised (*often due to collusion, corruption or other manipulations*), the Procuring Entity shall reject all Tenders and shall institute or cause competent Government Agencies to institute an investigation on the cause of the compromise, before retendering.

### **38. Unbalanced and/or Front-Loaded Tenders**

38.1 If in the Procuring Entity's opinion, the Tender that is evaluated as the lowest evaluated price is seriously unbalanced and/or front loaded, the Procuring Entity may require the Tenderer to provide written clarifications. Clarifications may include detailed price analyses to demonstrate the consistency of the tender prices with the scope of works, proposed methodology, schedule and any other requirements of the Tender document.

38.2 After the evaluation of the information and detailed price analyses presented by the Tenderer, the Procuring Entity may as appropriate:

- a) accept the Tender; or
- b) require that the total amount of the Performance Security be increased at the expense of the Tenderer to a level not exceeding a 10% of the Contract Price; or
- c) agree on a payment mode that eliminates the inherent risk of the Procuring Entity paying too much for undelivered works; or
- d) reject the Tender,

### **39. Qualifications of the Tenderer**

39.1 The Procuring Entity shall determine to its satisfaction whether the eligible Tenderer that is selected as having submitted the lowest evaluated cost and substantially responsive Tender, meets the qualifying criteria specified in Section III, Evaluation and Qualification Criteria.

39.2 The determination shall be based upon an examination of the documentary evidence of the Tenderer's qualifications submitted by the Tenderer, pursuant to ITT 17. The determination shall not take into consideration the qualifications of other firms such as the Tenderer's subsidiaries, parent entities, affiliates, subcontractors (other than Specialized Subcontractors if permitted in the Tender document), or any other firm(s) different from the Tenderer.

39.3 An affirmative determination shall be a prerequisite for award of the Contract to the Tenderer. A negative determination shall result in disqualification of the Tender, in which event the Procuring Entity shall proceed to the Tenderer who offers a substantially responsive Tender with the next lowest evaluated price to make a similar determination of that Tenderer's qualifications to perform satisfactorily.

### **40. Lowest Evaluated Tender**

Having compared the evaluated prices of Tenders, the Procuring Entity shall determine the Lowest Evaluated Tender. The Lowest Evaluated Tender is the Tender of the Tenderer that meets the Qualification Criteria and whose Tender has been determined to be:

- a) Most responsive to the Tender document; and
- b) The lowest evaluated price.

#### **41. Procuring Entity's Right to Accept Any Tender, and to Reject Any or All Tenders.**

The Procuring Entity reserves the right to accept or reject any Tender and to annul the Tender process and reject all Tenders at any time prior to Contract Award, without there by incurring any liability to Tenderers. In case of annulment, all Tenders submitted and specifically, Tender securities, shall be promptly returned to the Tenderers.

### **F. AWARD OF CONTRACT**

#### **42. Award Criteria**

The Procuring Entity shall award the Contract to the successful tenderer whose tender has been determined to be the Lowest Evaluated Tender.

#### **43. Notice of Intention to enter into a Contract**

Upon award of the contract and Prior to the expiry of the Tender Validity Period the Procuring Entity shall issue a Notification of Intention to Enter into a Contract/Notification of award to all tenderers which shall contain, at a minimum, the following information:

- a) the name and address of the Tenderer submitting the successful tender;
- b) the Contract price of the successful tender;
- c) a statement of the reason(s) the tender of the unsuccessful tenderer to whom the letter is addressed was unsuccessful, unless the price information in (c) above already reveals the reason;
- d) the expiry date of the Standstill Period; and
- e) instructions on how to request a debriefing and/or submit a complaint during the stand still period;

#### **44. Stand still Period**

- 42.1 The Contract shall not be signed earlier than the expiry of a Standstill Period of 14 days to allow any dissatisfied tender to launch a complaint. Where only one Tender is submitted, the Standstill Period shall not apply.
- 42.2 Where a Standstill Period applies, it shall commence when the Procuring Entity has transmitted to each Tenderer the Notification of Intention to Enter into a Contract with the successful Tenderer.

#### **45. Debriefing by the Procuring Entity**

- 45.1 On receipt of the Procuring Entity's Notification of Intention to Enter into a Contract referred to in ITT 43, an unsuccessful tenderer may make a concern(s) regarding their tender. The Procuring Entity shall provide the debriefing within five days of receipt of the request.
- 45.2 Debriefings of unsuccessful Tenderers may be done in writing or verbally. The Tenderer shall bear its own costs of attending such a debriefing meeting.

#### **46. Letter of Award**

Prior to the expiry of the Tender Validity Period and upon expiry of the Standstill Period specified in ITT 42.1, upon addressing a complaint that has been filed within the Standstill Period, the Procuring Entity shall transmit the Letter of Award to the successful Tenderer. The letter of award shall request the successful tenderer to furnish the Performance Security within 21 days of the date of the letter.

#### **47. Signing of Contract**

- 47.1 Upon the expiry of the fourteen days of the Notification of Intention to enter into contract and upon the parties meeting their respective statutory requirements, the Procuring Entity shall send the successful Tenderer the Contract Agreement.

- 47.2 Within fourteen (14) days of receipt of the Contract Agreement, the successful Tenderer shall sign, date, and return it to the Procuring Entity.
- 47.3 The written contract shall be entered into within the period specified in the notification of award and before expiry of the tender validity period.

#### **48. Performance Security**

- 48.1 Within twenty-one (21) days of the receipt of the Letter of Award from the Procuring Entity, the successful Tenderer shall furnish the Performance Security and, any other documents required in the **TDS**, in accordance with the General Conditions of Contract, subject to ITT 38.2 (b), using the Performance Security and other Forms included in Section X, Contract Forms, or another form acceptable to the Procuring Entity. A foreign institution providing a bank guarantee shall have a correspondent financial institution located in Kenya, unless the Procuring Entity has agreed in writing that a correspondent bank is not required.
- 48.2 Failure of the successful Tenderer to submit the above-mentioned Performance Security and other documents required in the **TDS** or sign the Contract shall constitute sufficient grounds for the annulment of the award and forfeiture of the Tender Security. In that event the Procuring Entity may award the Contract to the Tenderer offering the next Best Evaluated Tender.
- 48.3 Performance security shall not be required for contract estimated to cost less than the amount specified in the Regulations.

#### **49. Publication of Procurement Contract**

Within fourteen days after signing the contract, the Procuring Entity shall publish the awarded contract at its notice boards and websites; and on the Website of the Authority. At the minimum, the notice shall contain the following information:

- a) name and address of the Procuring Entity;
- b) name and reference number of the contract being awarded, a summary of its scope and the selection method used;
- c) the name of the successful Tenderer, the final total contract price, the contract duration.
- d) dates of signature, commencement and completion of contract;
- e) names of all Tenderers that submitted Tenders, and their Tender prices as read out at Tender opening.

#### **50. Procurement Related Complaint**

The procedures for making Procurement-related Complaints shall be specified in the **TDS**.

### SECTION III - TENDER DATA SHEET (TDS)

The following specific data for the Works and Services to be procured shall complement, supplement, or amend the provisions in the Instructions to Tenderers (ITT). Whenever there is a conflict, the provisions herein shall prevail over those in ITT.

<b>A. General</b>	
ITT1.1	<p>The name of the Tender is : <u>Periodic Maintenance of Kampi ya Moto – Eminging (B17) Road</u></p> <p>The Reference number of the Tender is <u>[KeNHA/R4/304/2024]</u></p> <p>The number and identification of the lots (contracts) comprising the Tender are:</p> <p>Lot 1- Name <u>NA</u></p> <p>Lot 2- Name <u>NA</u></p> <p>Lot 3- Name <u>NA</u></p> <p>ETC</p>
ITT2.3	<p>The information made available to competing firms is as follows: <b>NONE</b></p>
ITT2.4	<p>The firms that provided consultancy services for the contract being tendered for are: <b>NONE</b></p>
ITT3.1	<p>Maximum number of members in the JV shall be: <i>N/A</i></p>
ITT3.10	<p>Citizen contractors are encouraged to source locally manufactured items/materials and locally assembled machines, equipment, vehicles, labour etc.</p>
<b>B. Contents of Tender Documents</b>	
ITT 7.1	<p>i) The Tenderer will submit any request for clarification in writing at the Address <b><i>Provided in the detailed Tender Notice</i></b></p> <p>To reach the Procuring Entity not later than <b>7 days</b> before bid submission deadline</p> <p>as indicated in the Tender Notice</p> <p>ii) The Procuring Entity will publish the response at the Website <u><a href="http://www.kenha.co.ke">www.kenha.co.ke</a></u></p>
ITT 7.2	<p>There shall be a mandatory pre-tender site visits as specified in the detailed tender notice</p>
ITT 7.3	<p>The Tenderer will submit any questions in writing, to reach the Procuring Entity not later than the date specified in TDS- ITT 7.1</p>
ITT 7.5	<p>The Procuring Entity's website where Minutes of the pre-Tender meeting and</p>

	the pre- arranged pretender will be published is <a href="http://www.kenha.co.ke">www.kenha.co.ke</a>
<b>C. Preparation of Tenders</b>	
ITP 11.1(h)	The Tenderer shall submit the following additional documents in its Tender: As indicated in the <i>Qualification Form/Criteria</i>
ITT 13.1	Alternative Tenders <b>shall not</b> be considered. [If alternatives shall be considered, the methodology shall be defined in Section III, Evaluation and Qualification Criteria.]
ITT 13.2	Alternative times for completion <b>shall not be permitted</b>
ITT 13.4	Alternative technical solutions shall be permitted for the following parts of the Works: <b>None</b>
ITT 14.5	The prices quoted by the Tenderer shall be: <b>fixed</b>
ITT 15.2	Foreign currency requirements: <b>not allowed.</b>
ITT 18.1	The Tender validity period shall be <b>140days</b> from the specified date of opening as indicated in the invitation to Tender
ITT 18.2	a) The Number of days beyond the expiry of the initial tender validity period will be 60 days.  (b) The Tender price shall be adjusted by the following percentages of the tender price:  (i) By 0 % of the local currency portion of the Contract price adjusted to reflect local inflation during the period of extension,  and  (ii) By 0 % the foreign currency portion of the Contract price adjusted to reflect the international inflation during the period of extension.
ITT 19.1	A Tender Security of the amount specified in the Appendix to form of Bid <b>shall be</b> required.
19.2 (h)	The other security is <b><u>Not Applicable</u></b>
ITT 19.5	Other documents required are as specified in <b>Form No. 3; Contract Agreement</b>
ITT 19.9	The Procuring Entity will declare the Tenderer ineligible to be awarded contracts by the Procuring Entity for a period of <b>two (2)</b> years.
ITT 20.1	In addition to the original of the Tender, the number of copies is: <b><u>NONE</u></b>
ITT 20.3	The written confirmation of authorization to sign on behalf of the Tenderer shall consist of: <b><u>Certificate of Independent Tender Determination Part B of Form of</u></b>

	<u>Tender</u>
<b>D. Submission and Opening of Tenders</b>	
ITT 21.3	A tender package or container that cannot fit in the tender box shall be received follows: shall be received at the Supply Chain Management Offices of the location specified in the tender notice.
ITT 22.1	(A) For <u>Tender submission purposes</u> only, the Procuring Entity's address is: As indicated in the <b>Invitation to Tender</b>  Tenders <b>shall not be submitted</b> electronically.
ITT 25.1	If Tenderers are allowed to submit Tenders electronically, they shall follow the electronic tender submission procedures <b>specified below</b> <i>Not Applicable</i>
ITT 25.6	The number of representatives of the Procuring Entity to sign is <b>at least three</b>
<b>E. Evaluation, and Comparison of Tenders</b>	
ITT 30.3	The adjustment shall be based on the average price of the item or component as quoted in other substantially responsive Tenders. If the price of the item or component cannot be derived from the price of other substantially responsive Tenders, the Procuring Entity shall use its Lowest estimate.
ITT 31.2	The error shall be considered a major deviation that leads to disqualification of the tender if the percentage of the error (error over the tender price quoted) is: <b>more than 0% or less than 0%.</b>
ITT 32.1	The currency that shall be used for Tender evaluation and comparison purposes is:- <i>Kenya Shillings</i>
ITT 33.2	A margin of preference <i>shall</i> apply.  <i>[If a margin of preference applies, the application methodology shall be defined in Section III - Evaluation and Qualification Criteria.]</i>
ITT 33.4	The invitation to tender is extended to the following groups that qualify for reservations- <b>ALL</b>
ITT 34.1	At this time, the Procuring Entity <b><i>does not intend</i></b> to execute certain specific parts of the Works by subcontractors selected in advance.
ITT 34.2	Contractor's may propose subcontracting: Maximum percentage of subcontracting permitted is: <b>40% of the total contract amount.</b> Tenderers planning to subcontract more than 10% of total volume of work shall specify, in the Form of Tender, the activity (ies) or parts of the Works to be subcontracted along with complete details of the subcontractors and their qualification and experience.
ITT 34.3	The parts of the Works for which the Procuring Entity permits Tenderers to

	<p>propose Specialized Subcontractors are designated as follows:</p> <p>For the above-designated parts of the Works that may require Specialized Subcontractors, the relevant qualifications of the proposed Specialized Subcontractors will be added to the qualifications of the Tenderer for the purpose of evaluation. <b>N/A</b></p>
<b>ITT 35.2 (d)</b>	Additional requirements apply. These are detailed in the evaluation criteria in Section III, Evaluation and Qualification Criteria.
<b>ITT 37</b>	Abnormally High/low Tenders shall be treated as per the procedure outlined in Section IV, Evaluation and Qualification Criteria
<b>ITT 38</b>	Unbalanced or Front loaded Tenders shall be treated as per the procedure outlined in Section IV, Evaluation and Qualification Criteria
<b>ITT 48.2</b>	Additional requirements are: As detailed in the Qualification Criteria/Form
<b>ITT 49.1</b>	<p>The procedures for making a Procurement-related Complaint are available from the PPRA website <a href="mailto:info@ppra.go.ke">info@ppra.go.ke</a> or <a href="mailto:complaints@ppra.go.ke">complaints@ppra.go.ke</a>. If a Tenderer wishes to make a Procurement-related Complaint, the Tenderer should submit its complaint following these procedures, in writing (by the quickest means available, that is either by hand delivery or email to:</p> <p>For the attention: <b>Director General</b></p> <p>Procuring Entity: <b>Kenya National Highways Authority (KeNHA)</b></p> <p>Email address: <b>dg@kenha.co.ke</b></p> <p>In summary, a Procurement-related Complaint may challenge any of the following:</p> <p>(i) the terms of the Tender Documents; and</p> <p>(ii) the Procuring Entity's decision to award the contract.</p>

## SECTION IV- EVALUATION AND QUALIFICATION CRITERIA

### General Provisions

#### 1 General Provisions

- 11 This section contains the criteria that the Employer shall use to evaluate tender and qualify tenderers. No other factors, methods or criteria shall be used other than specified in this tender document. The Tenderer shall provide all the information requested in the forms included in Section IV, Tendering Forms. The Procuring Entity shall use **the Standard Tender Evaluation Document for Goods and Works** for evaluating Tenders.
- 12 Wherever a Tenderer is required to state a monetary amount, Tenderers should indicate the Kenya Shilling equivalent using the rate of exchange determined as follows:
  - a) For construction turnover or financial data required for each year - Exchange rate prevailing on the last day of the respective calendar year (in which the amounts for that year is to be converted) was originally established.
  - b) Value of single contract - Exchange rate prevailing on the date of the contract signature.
  - c) Exchange rates shall be taken from the publicly available source identified in the ITT 14.3. Any error in determining the exchange rates in the Tender may be corrected by the Procuring Entity.
- 13 Evaluation and contract award Criteria

The Procuring Entity shall use the criteria and methodologies listed in this Section to evaluate tenders and arrive at the Lowest Evaluated Tender. The tender that (i) meets the qualification criteria, (ii) has been determined to be substantially responsive to the Tender Documents, and (iii) is determined to have the Lowest Evaluated Tender price shall be selected for award of contract.

#### 2. Preliminary examination for Determination of Responsiveness

The Procuring Entity will start by examining all tenders to ensure they meet in all respects the eligibility criteria and other requirements in the ITT, and that the tender is complete in all aspects in meeting the requirements of “Part 2 – Procuring Entity's Works Requirements”, including checking for tenders with unacceptable errors, abnormally low tenders, abnormally high tenders and tenders that are front loaded. The Standard Tender Evaluation Report for Goods and Works for evaluating Tenders provides clear guidelines on how to deal with review of these requirements. Tenders that do not pass the Preliminary Examination will be considered irresponsive and will not be considered further.

*[The Procuring Entity will provide the preliminary evaluation criteria. To facilitate, a template may be attached or clearly described all information and list of documentation to be submitted by Tenderers to enable preliminary evaluation of the Tender]*

#### 3. Tender Evaluation (ITT 35)

**Price evaluation:** In addition to the criteria listed in ITT 35.2 (a) – (d) the following criteria shall apply:

- i) **Alternative Completion Times**, if permitted under ITT 13.2, will be evaluated as follows:  
.....N/A.....
- ii) **Alternative Technical Solutions** for specified parts of the Works, if permitted under ITT 13.4, will be evaluated as follows: .....N/A.....
- iii) **Other Criteria**; if permitted under ITT 35.2(d): .....N/A.....

## **4. Multiple Contracts**

4.1 Multiple contracts will be permitted in accordance with ITT 35.4. Tenderers are evaluated on basis of Lots and the lowest evaluated tenderer identified for each Lot. The Procuring Entity will select one Option of the two Options listed below for award of Contracts.

### **OPTION 1**

- i) If a tenderer wins only one Lot, the tenderer will be awarded a contract for that Lot, provided the tenderer meets the Eligibility and Qualification Criteria for that Lot.
- ii) If a tenderer wins more than one Lot, the tender will be awarded contracts for all won Lots, provided the tenderer meets the aggregate Eligibility and Qualification Criteria for all the Lots. The tenderer will be awarded the combination of Lots for which the tenderer qualifies and the others will be considered for award to second lowest the tenderers.

### **OPTION 2**

The Procuring Entity will consider all possible combinations of won Lots [contract(s)] and determine the combinations with the lowest evaluated price. Tenders will then be awarded to the Tenderer or Tenderers in the combinations provided the tenderer meets the aggregate Eligibility and Qualification Criteria for all the won Lots.

## **6. Alternative Tenders (ITT 13.1)**

*An alternative if permitted under ITT 13.1, will be evaluated as follows:*

The Procuring Entity shall consider Tenders offered for alternatives as specified in Part2-Works Requirements. Only the technical alternatives, if any, of the Tenderer with the Best Evaluated Tender conforming to the basic technical requirements shall be considered by the Procuring

## **7. Margin of Preference**

- 5.1 If the TDS so specifies, the Procuring Entity will grant a margin of preference of fifteen percent (15%) to be loaded one valuated price of the foreign tenderers, where the percentage of shareholding of Kenyan citizens is less than fifty-one percent (51%).
- 5.2 Contractors applying for such preference shall be asked to provide, as part of the data for qualification, such information, including details of ownership, as shall be required to determine whether, according to the classification established by the Procuring Entity, a particular contract or or group of contractors qualifies for a margin of preference.
- 5.3 After Tenders have been received and reviewed by the Procuring Entity, responsive Tenders shall be assessed to ascertain their percentage of shareholding of Kenyan citizens. Responsive tenders to shall be classified into the following groups:
  - i) Group A: tenders offered by Kenyan Contractors and other Tenderers where Kenyan citizens hold shares of over fifty one percent (51%).
  - ii) Group B: tenders offered by foreign Contractors and other Tenderers where Kenyan citizens hold shares of less than fifty one percent (51%).
- 5.4 All evaluated tenders in each group shall, as a first evaluation step, be compared to determine the lowest tender, and the lowest evaluated tender in each group shall be further compared with each other. If, as a result of this comparison, a tender from Group A is the lowest, it shall be selected for the award. If a tender from Group B is the lowest, an amount equal to the percentage indicated in Item 3.1 of the respective tender price, including unconditional discounts and excluding provisional sums and the cost of day works, if any, shall be added to the evaluated price offered in each tender from Group B. All tenders shall then be compared using new prices with added prices to Group Band the lowest evaluated tender from Group A. If the tender from Group A is still the lowest tender, it shall be selected for award. If not, the lowest evaluated tender from Group B based on the first evaluation price shall be selected.

**6. Post qualification and Contract award (ITT 39), more specifically,**

- a) In case the tender was subject to post-qualification, the contract shall be awarded to the lowest evaluated tenderer, subject to confirmation of pre-qualification data, if so required.
- b) In case the tender was not subject to post-qualification, the tender that has been determined to be the lowest evaluated tenderer shall be considered for contract award, subject to meeting each of the following conditions.
  - i) The Tenderer shall demonstrate that it has access to, or has available, liquid assets, unencumbered real assets, lines of credit, and other financial means (independent of any contractual advance payment) sufficient to meet the construction cash flow of Kenya Shillings \_\_\_\_\_.
  - ii) Minimum average annual construction turnover of Kenya Shillings \_\_\_\_\_ *[insert amount]*, equivalent calculated as total certified payments received for contracts in progress and/or completed within the last \_\_\_\_\_ *[insert of year]* years.
  - iii) At least \_\_\_\_\_ *(insert number)* of contract(s) of a similar nature executed within Kenya, or the East African Community or abroad, that have been satisfactorily and substantially completed as a prime contractor, or joint venture member or sub-contractor each of minimum value Kenya shillings \_\_\_\_\_ equivalent.
  - iv) Contractor's Representative and Key Personnel, which are specified as \_\_\_\_\_
  - v) Contractors key equipment listed on the table "Contractor's Equipment" below and more specifically listed as *[specify requirements for each lot as applicable]* \_\_\_\_\_
  - vi) Other conditions depending on their seriousness.
- c) **History of non-performing contracts:**

Tenderer and each member of JV incase the Tenderer is a JV, shall demonstrate that Non-performance of a contract did not occur because of the default of the Tenderer, or the member of a JV in the last \_\_\_\_\_ *(specify years)*. The required information shall be furnished in the appropriate form.
- d) **Pending Litigation**

Financial position and prospective long-term profitability of the Single Tenderer, and in the case the Tenderer is a JV, of each member of the JV, shall remain sound according to criteria established with respect to Financial Capability under Paragraph (i) above if all pending litigation will be resolved against the Tenderer. Tenderer shall provide information on pending litigations in the appropriate form.
- e) **Litigation History**

There shall be no consistent history of court/arbitral award decisions against the Tenderer, in the last \_\_\_\_\_ *(specify years)*. All parties to the contract shall furnish the information in the appropriate form about any litigation or arbitration resulting from contracts completed or ongoing under its execution over the years specified. A consistent history of awards against the Tenderer or any member of a JV may result in rejection of the tender.

## **SECTION IV: EVALUATION AND QUALIFICATION CRITERIA CONTD...**

This Section contains all the factors, methods and criteria that the Employer shall use to evaluate applications. The information to be provided in relation to each factor and the definitions of the corresponding terms are included in the respective Application Forms.

1. Eligibility Requirements
2. Historical Contract Non-Performance
3. Financial Situation
4. Technical/Engineering Works Experience
5. Program of Works and Work Methodology
6. Key Professional and Technical Site Staff
7. Major Plant and Equipment to be used in the Project

## QUALIFICATION FORM

Item No.	Qualification Subject	Qualification Requirement	<i>Document To be Completed/provided by Tenderer</i>	<i>For Procuring Entity's Use (Qualification met or Not Met)</i>
<b>A. PRELIMINARY EVALUATION</b>				
1.	Nationality	Nationality in accordance with ITT 3.10	Forms ELI - 1.1, 1.2 and 1.3, with attachments	
2.	Goods, equipment and services to be supplied under the contract	To have their origin in any country that is not determined ineligible under ITT 4.1	Forms ELI - 1.4	
3.	Conflict of Interest	No conflicts of interest in accordance with ITT 3.3	Form of Tender	
4.	<b>PPRA Eligibility</b>	Not having been declared ineligible by the PPRA as described in ITT 3.7	Form of Tender - <b>Form SD 1</b>	
5.	State- owned Enterprise	Meets conditions of ITT 3.8	Forms ELI - 1.1 and 1.2, with attachments	
6.	Appendix to Form of Bid	Form properly filled & signed	Appendix to Form of Bid in the Prescribed Format	
7.	Suspension Based on Execution of Tender/Proposal Securing Declaration by the Procuring Entity	Not under suspension based on-execution of a Tender/Proposal Securing Declaration pursuant to ITT 19.8.	To be confirmed from Internal records by the procuring entity	
8.	Pending Litigation	Tender's financial position and prospective long-term profitability still sound according to criteria established in 3.1 and assuming that all pending litigation will NOT be resolved against the Tenderer.	Form CON - 1	

<b>Item No.</b>	<b>Qualification Subject</b>	<b>Qualification Requirement</b>	<b>Document To be Completed/provided by Tenderer</b>	<b>For Procuring Entity's Use (Qualification met or Not Met)</b>
9.	Litigation History	No consistent history of court/arbitral award decisions against the Tenderer for the last three (3) years.	Form CON - 1	
10.	Declaration of Fair employment laws and practices	Bidders shall declare they are not guilty of any serious violation of fair employment laws and practices and will be bound to abide by the industry CBA at minimum	Form CON - 2	
11.	Declaration of Knowledge of Site /Pre-Bid Conference	<ul style="list-style-type: none"> <li>• Attend Pre-Tender Site Visits as per TDS, ITT 7.1</li> <li>• Bidders to sign attendance register</li> <li>• Certificate must be signed by the Employer's representative</li> <li>• Bidders to send Technical Persons for the Site Visit – Min Qualifications – Diploma in Civil Engineering</li> </ul>	Form CON - 3	
12.	Tender Security	Tender Security document	a) Form in the Prescribed Format b) Digital Tender Securities will be accepted	
13.	Priced Bill of Quantities	<ul style="list-style-type: none"> <li>- Fill all rates, and amounts,</li> <li>- NO Alterations of the Quantities accepted,</li> <li>- All bidders own Corrections must be Countersigned</li> <li>- NO Errors noted in the Bills of Quantities</li> </ul>	Bills of Quantity in the Prescribed Format	
14.	Annual Practicing License with the National Construction Authority	Proof of registration with the National Construction Authority in Class <b>1, 2 or 3</b> as Roads/Bridges Contractor	Copy of Current NCA Practicing License	

Item No.	Qualification Subject	Qualification Requirement	Document To be Completed/provided by Tenderer	For Procuring Entity's Use (Qualification met or Not Met)
15.	Tax Obligations for Kenyan Tenderers	Has produced a current tax clearance certificate or tax exemption certificate issued by the Kenya Revenue Authority in accordance with ITT 4.15.	<i>Provide Valid Tax Compliance Certificate</i>	
16.	Serialization of the Bid	Bidders shall sequentially serialize all pages of each tender submitted.  Any written Pages or document attached or inserted Documents <b>MUST</b> be sequentially serialized.	The Serialization <b>MUST</b> be numerically sequential starting from Numeric 1.	
17.	Completeness of tender document	The person or persons signing the bid <b>shall</b> initial all pages of the bid where entries have been made.  Bidders shall own all alterations made to the tender document.  Bidders shall duly fill all relevant forms/schedules provided for in the document that requires entries	All pages with entries (Typed or hand written) must be initialed.  Any alterations made in the tender document must be countersigned.  All relevant Forms/ Schedules shall be duly filled	
18.	Proposed Weightings	Duly filled and signed Schedule H	Bidder to fill Schedule H: Basic Prices for Materials and Labour	
19.	Rates Derivation	Bidder shall provide current (at least 30 days before tender opening) proof of cost of materials e.g. Proforma invoices/quotation (cement bitumen etc.)	Bidder to fill Schedule G: Part I. Schedule of Materials: Basic Prices Part II. Schedule of rates derivation	

Item No.	Qualification Subject	Qualification Requirement	Document To be Completed/provided by Tenderer	For Procuring Entity's Use (Qualification met or Not Met)
<b>B. TECHNICAL EVALUATION</b>				
1.	History of Non-Performing Contracts	<p>Non-performance of a contract did not occur as a result of contractor default for the last three (3) years.</p> <p>Non-performance shall be deemed to have occurred by evidence of:</p> <ul style="list-style-type: none"> <li>• <i>Termination Letter</i></li> <li>• <i>Liquidated Damages</i></li> </ul>	<p>Form CON-1</p> <p><b><i>If a bidder fails to disclose, shall be disqualified</i></b></p> <p><b><i>Reference to be made to procuring Authority's records</i></b></p> <p><b><i>A bidder with any history of non-performance earns zero(0) marks</i></b></p>	10 Marks
2.	Financial Capabilities	(i) Bidders shall provide audited balance sheets or, if not required by the laws of the Tenderer's country, other financial statements acceptable to the Procuring Entity, for the last <b>3 years</b> shall be submitted and must demonstrate the current soundness of the Tenderer's financial position and indicate its prospective long-term profitability (as demonstrated by Financial Evaluation ratios).	<p>Form FIN - 3.1, with attachments</p> <p><b><i>Attachments include:</i></b></p> <p><b><i>i. Audited accounts</i></b></p> <p><b><i>All pages must be initialed and stamped by both a practicing Auditor registered with ICPAK and one of the Directors. Auditor's practicing membership number from ICPAK must be indicated and a valid practicing license shall be provided.</i></b></p> <p><b><i>The Financial ratio Form to be signed by the Auditor registered with ICPAK and one of the Directors</i></b></p>	10 Marks  1 Mark

Item No.	Qualification Subject	Qualification Requirement	Document To be Completed/provided by Tenderer	For Procuring Entity's Use (Qualification met or Not Met)
		<p>(ii) The Tenderer shall demonstrate that it has access to, or has available, liquid assets, unencumbered real assets, lines of credit, and other financial means (independent of any contractual advance payment) sufficient to meet the construction cash flow requirements estimated at a minimum of 10% of the bid price for the subject contract(s) net of the Tenderer's other commitments.</p> <p>The Tenderers shall also demonstrate, to the satisfaction of the Procuring Entity, that it has adequate sources of finance to meet the cash flow requirements on works currently in progress and for future contract commitments.</p>	<ul style="list-style-type: none"> <li>• <b>Financial Ratios</b> Computation shall be made for the following Ratios and marks awarded to each of the ratios: -Working Capital - Debt to Equity Ratio - Current ratio - Operating Cash Flow ratio</li> <li>• <b>Line of Credit</b></li> <li>• <b>Bank statements</b></li> <li><b>Etc.</b></li> </ul>	<p>4 Marks</p> <p>4 Marks</p>
3.	Average Annual Construction	Minimum average annual construction turnover of Kenya Shillings [350 Million], equivalent	Form FIN - 3.2 <b>Attachments include Financial Statements</b>	1 Marks

Item No.	Qualification Subject	Qualification Requirement	Document To be Completed/provided by Tenderer	For Procuring Entity's Use (Qualification met or Not Met)
	Turnover	calculated as total certified payments received for contracts in progress and/or completed within the last <b>3 years</b> , divided by <b>3 years</b>		
4.	Ongoing Works	Value of outstanding works shall not be more than the bid price	Form FIN - 3.4 If the outstanding Works is more than the bid price of this bid, the bidder loses the full marks.	2marks
5.	General Construction Experience	Experience under construction contracts in the role of prime contractor, JV member, sub-contractor, or management contractor, substantially completed in the last [ <b>5 years</b> ] prior to the applications submission deadline.	Form EXP -4.1 <b>Attach Letters of Award and Completion Certificates</b>	3 Marks (1 Mark for each General Construction project)
6.	Specific Construction & Contract Management Experience	Participation in contract (s) of a similar nature with minimum cumulative value of <b>KSh. (700 Million)</b> as filled in Form EXP 4.2(a) that have been satisfactorily and substantially completed by the bidder, as a prime contractor, joint venture member, management contractor or sub-contractor in the last [5 years] prior to the applications submission deadline. The similarity shall be based on the physical size, complexity,	Form EXP 4.2(a)&(b) <b>Provide Letters of Award and Completion Certificates</b> <b>For subcontracted works, the bidder should provide the following;</b> <ul style="list-style-type: none"> <li>• <b>Award letter of the main contractor</b></li> <li>• <b>Award letter of the</b></li> </ul>	10 Marks

Item No.	Qualification Subject	Qualification Requirement	Document To be Completed/provided by Tenderer	For Procuring Entity's Use (Qualification met or Not Met)																
		methods/technology or other characteristics	<p><i>subcontract.</i></p> <ul style="list-style-type: none"> <li>• <i>Completion letter of the subcontract.</i></li> <li>• <i>Subcontract approval from the Engineer/supervision Authority</i></li> </ul>																	
7.	Contractor's Representative and Key Personnel	<p>Curriculum Vitae (CVs) of the Proposed Key Staff must be presented in the provided format and duly signed by the proposed individual.</p> <p>Copies of certificates and Annual Practicing Licenses (for Engineers) and Academic Certificates for all staff is mandatory;</p>	Schedule F (Form PER. 1 and PER. 2)	10 Marks																
		<table border="1"> <tr> <td data-bbox="555 932 808 1345" rowspan="4">Site Agent / Road Manager</td> <td data-bbox="808 932 1032 1034">Certification</td> <td data-bbox="1032 932 1335 1034">Current EBK Licence</td> <td data-bbox="1335 932 1532 1034">2</td> </tr> <tr> <td data-bbox="808 1034 1032 1219">Qualifications in Civil/ Highway Engineering</td> <td data-bbox="1032 1034 1335 1219">Degree</td> <td data-bbox="1335 1034 1532 1219">1</td> </tr> <tr> <td data-bbox="808 1219 1032 1345" rowspan="2">Experience</td> <td data-bbox="1032 1219 1335 1283">Above 5 years</td> <td data-bbox="1335 1219 1532 1283">2</td> </tr> <tr> <td data-bbox="1032 1283 1335 1345">0-5 years</td> <td data-bbox="1335 1283 1532 1345">0</td> </tr> <tr> <td data-bbox="555 1345 808 1423">Engineer</td> <td data-bbox="808 1345 1032 1423">Qualifications in Civil/</td> <td data-bbox="1032 1345 1335 1423">Degree</td> <td data-bbox="1335 1345 1532 1423">2</td> </tr> </table>			Site Agent / Road Manager	Certification	Current EBK Licence	2	Qualifications in Civil/ Highway Engineering	Degree	1	Experience	Above 5 years	2	0-5 years	0	Engineer	Qualifications in Civil/	Degree	2
Site Agent / Road Manager	Certification	Current EBK Licence	2																	
	Qualifications in Civil/ Highway Engineering	Degree	1																	
	Experience	Above 5 years	2																	
		0-5 years	0																	
Engineer	Qualifications in Civil/	Degree	2																	

Item No.	Qualification Subject	Qualification Requirement		Document To be Completed/provided by Tenderer		For Procuring Entity's Use (Qualification met or Not Met)
			Highway Engineering			
			Experience	Above 5 years	1	
				0-5 years	0	
		Foreman	Qualifications in Civil/ Highway Engineering	Degree	1	
				HND	1	
				Diploma	1	
			Experience	Above 5 years	1	
				0-5 years	0	
8.	Contractors key equipment		<ul style="list-style-type: none"> <li>Bidders shall declare they have possession/Ownership of various equipment as proposed to be used in the Project by providing Logbooks that demonstrate proof of ownership</li> <li>For Bidders planning to hire, they shall provide an Active Lease Agreement in Place that can be used during the Project Life. The copy of logbooks of the lessor(s) shall also be provided.</li> </ul>		Schedule D of Technical Proposal	

Item No.	Qualification Subject	Qualification Requirement	Document To be Completed/provided by Tenderer	For Procuring Entity's Use (Qualification met or Not Met)																																						
9.		<table border="1" data-bbox="573 424 1800 995"> <thead> <tr> <th data-bbox="573 424 887 560" rowspan="2">Main Scope of Works of this Tender</th> <th data-bbox="887 424 1265 560" rowspan="2">Main Equipment</th> <th data-bbox="1265 424 1458 560" rowspan="2">Quantity (No) (Minimum)</th> <th colspan="2" data-bbox="1458 424 1800 483">Marks (Score)</th> </tr> <tr> <th data-bbox="1458 483 1630 560">Owned</th> <th data-bbox="1630 483 1800 560">Hired/ leased</th> </tr> </thead> <tbody> <tr> <td colspan="3" data-bbox="573 560 1458 600"><b>Total</b></td> <td data-bbox="1458 560 1630 600"></td> <td data-bbox="1630 560 1800 600"></td> </tr> <tr> <td data-bbox="573 600 887 959" rowspan="5"><b>Periodic Mtce / (paved)</b></td> <td data-bbox="887 600 1265 667">Paver</td> <td data-bbox="1265 600 1458 667">1</td> <td data-bbox="1458 600 1630 667">15</td> <td data-bbox="1630 600 1800 667">5</td> </tr> <tr> <td data-bbox="887 667 1265 734">Bitumen Distributor</td> <td data-bbox="1265 667 1458 734">1</td> <td data-bbox="1458 667 1630 734">10</td> <td data-bbox="1630 667 1800 734">5</td> </tr> <tr> <td data-bbox="887 734 1265 801">Pneumatic roller</td> <td data-bbox="1265 734 1458 801">1</td> <td data-bbox="1458 734 1630 801">3</td> <td data-bbox="1630 734 1800 801">1.5</td> </tr> <tr> <td data-bbox="887 801 1265 879">Drum roller (Minimum 10 Tons)</td> <td data-bbox="1265 801 1458 879">1</td> <td data-bbox="1458 801 1630 879">3</td> <td data-bbox="1630 801 1800 879">1.5</td> </tr> <tr> <td data-bbox="887 879 1265 959">Tippers (Cumulative Capacity 28 Tons)</td> <td data-bbox="1265 879 1458 959">2</td> <td data-bbox="1458 879 1630 959">4</td> <td data-bbox="1630 879 1800 959">2</td> </tr> <tr> <td colspan="3" data-bbox="573 959 1458 995"><b>Total</b></td> <td data-bbox="1458 959 1630 995"><b>35</b></td> <td data-bbox="1630 959 1800 995"><b>15</b></td> </tr> </tbody> </table>	Main Scope of Works of this Tender	Main Equipment	Quantity (No) (Minimum)	Marks (Score)		Owned	Hired/ leased	<b>Total</b>					<b>Periodic Mtce / (paved)</b>	Paver	1	15	5	Bitumen Distributor	1	10	5	Pneumatic roller	1	3	1.5	Drum roller (Minimum 10 Tons)	1	3	1.5	Tippers (Cumulative Capacity 28 Tons)	2	4	2	<b>Total</b>			<b>35</b>	<b>15</b>		
Main Scope of Works of this Tender	Main Equipment	Quantity (No) (Minimum)				Marks (Score)																																				
			Owned	Hired/ leased																																						
<b>Total</b>																																										
<b>Periodic Mtce / (paved)</b>	Paver	1	15	5																																						
	Bitumen Distributor	1	10	5																																						
	Pneumatic roller	1	3	1.5																																						
	Drum roller (Minimum 10 Tons)	1	3	1.5																																						
	Tippers (Cumulative Capacity 28 Tons)	2	4	2																																						
<b>Total</b>			<b>35</b>	<b>15</b>																																						
10.	Proposed methodology	Adequacy and quality of the proposed methodology	<p data-bbox="1182 1107 1496 1174"><b>a) Technical approach and methodology</b></p> <ul data-bbox="1182 1193 1496 1260" style="list-style-type: none"> <li>• Provided a detailed Work Methodology:</li> </ul> <p data-bbox="1196 1279 1541 1423">a) Procedure on execution of activities as outlined in the BoQs</p> <p data-bbox="1196 1442 1541 1506">b) Allocation of machinery/labour in</p>	3 Marks																																						

Item No.	Qualification Subject	Qualification Requirement	Document To be Completed/provided by Tenderer	For Procuring Entity's Use (Qualification met or Not Met)
			<p>execution the activities</p> <p>c) Procedures in quality control of the activities described in BoQs</p> <ul style="list-style-type: none"> <li>• Provided a Methodology on safety during the construction period: <ul style="list-style-type: none"> <li>a) Personal protective equipment</li> <li>b) Signages</li> <li>c) Delineation of construction and passage of traffic</li> <li>d) Passage of traffic at night</li> </ul> </li> <li>• Provide a specific Quality management plan that covers the following: <ol style="list-style-type: none"> <li>1. Scope Management</li> <li>2. Time Management</li> <li>3. Material Quality Management</li> <li>4. Financial Management</li> <li>5. Risk Management</li> <li>6. Health &amp; Safety Management</li> </ol> </li> </ul>	<p>2 Marks</p> <p>2 Marks</p>

Item No.	Qualification Subject	Qualification Requirement	Document To be Completed/provided by Tenderer	For Procuring Entity's Use (Qualification met or Not Met)
			<p>7. Environmental Management</p> <p>8. Communication Management</p> <p>9. Procurement Management</p> <p>10. Human Resource Management</p> <p>Stakeholder Management</p> <p><b>b) Work plan/Program of Works (PoW)</b></p> <ul style="list-style-type: none"> <li>• PoW Resourced with Equipment-Min. allocation pursuant to the <b>Schedule E of Technical Proposal</b> - – To be submitted in A3 Size Paper well legible Fonts</li> <li>• PoW captures Monthly outputs for each activity</li> <li>• PoW details BoQ Quantities, Units and Rates</li> <li>• PoW is superimposed with Cashflow Projections as detailed in <b>Schedule A</b> of the technical proposal</li> </ul>	<p>4 Marks</p> <p>2 Marks</p> <p>2 Marks</p> <p>2 Marks</p>

Item No.	Qualification Subject	Qualification Requirement	Document To be Completed/provided by Tenderer	For Procuring Entity's Use (Qualification met or Not Met)
			c) <b>Site Organization and staffing</b> (Schedule B of Technical proposal)	3 Marks
11.	Knowledge Transfer [When transfer of knowledge is a particularly important component of the assignment, the following sub-criteria may be provided]	Transfer of knowledge (training) program (relevance of approach and methodology)	a) Relevance of training program [ <i>Not Applicable</i> ] b) Training approach and methodology [ <i>Not Applicable</i> ] c) Qualifications of experts and trainers [ <i>Not Applicable</i> ]	

*Tenderers who score less than the required pass (75%) will be automatically disqualified. Tenderers who meet the minimum pass mark in the technical evaluation will be evaluated further.*

**C. FINANCIAL EVALUATION:**

The lowest evaluated bidder shall be subjected to Financial Evaluation which include but not limited to **sensitivity analysis** of the **rates** to **detect abnormally low bids or abnormally high bids or unbalanced tenders or front loaded.**

**Treatment of Abnormally Low Bid/Abnormally high Bid/ Unbalanced bid**

The Procuring Entity may undertake an analysis of bidders' rates which are potentially lower/higher than the known prevailing market rates. The bidders shall be required to provide objective justification including supporting documents on derivation of their rates within stipulated time to the Procuring Entity (*See Schedule G, Part I&II on Derivation of Rates*).

In addressing the above criteria, the following steps shall be undertaken by the Procuring Entity;

<b>Item No.</b>	<b>Qualification Subject</b>	<b>Qualification Requirement</b>	<b><i>Document To be Completed/provided by Tenderer</i></b>	<b><i>For Procuring Entity's Use (Qualification met or Not Met)</i></b>
		<p>a. <b>Identify:</b> The Procuring Entity identifies a potential Abnormally Low/High Bid based on comparison with known prevailing market rates or with the project's total cost estimate.</p> <p>b. <b>Evaluate:</b> The Procuring Entity fully analyzes the Bidder's justification provided on schedule G to verify if it is an Abnormally Low/High Bid. Due diligence may be carried out by the Procuring Entity on the Bidder's documentation.</p> <p>c. <b>Determination:</b> The Procuring Entity fully documents the decision to accept or reject the Bid and executes appropriate action(s)/recommendation(s) including but not limited to enhancement of the performance security.</p> <p>In view of the above, the procuring Entity shall evaluate and analyze the Bidders' submissions against the known prevailing market rates and cost estimation guidelines. The analysis of the bidder's justification shall take into account all evidence provided. Accordingly, the Procuring Entity's relevant committee shall make a recommendation to the Accounting Officer.</p>		
		<p><b>D. POST QUALIFICATION:</b> The procuring entity may verify the documents provided by the bidder with the issuing authority.</p>		

**APPENDIX TO THE QUALIFICATION CRITERIA**

<b>ITEM</b>	<b>DESCRIPTION</b>		<b>POINT SCORE SCALE</b>	
<b>1</b>	<b>HISTORY OF NON-PERFORMANCE</b>		<b>Max 10</b>	
	History of Non-Performance		<b>0 or 10</b>	
<b>2</b>	<b>FINANCIAL CAPACITY</b>		<b>Max 10</b>	
	Audited Statements		0-1	
	Computation of Financial Ratios		0-4	
	Working capital to be at least 10% of the Bid Price		0-4	
	Turnover		0-1	
<b>3</b>	<b>EXPERIENCE</b>		<b>Max 22</b>	
	General Experience		0-6	
	Specific experience in related works		0-14	
	Workload Analysis		0-2	
<b>4</b>	<b>KEY PERSONNEL</b>		<b>Max 10</b>	
	Site Agent/Road Manager	Certification	Current EBK License	2
		Qualifications in Civil/Highway Engineering	Degree	1
		Experience	Above 5 years	2
			0-5 years	0
	Engineer	Qualifications in Civil/Highway Engineering	Degree	2
		Experience	Above 5 years	1
			0-5 years	0
	Foreman	Qualifications in Civil/Highway Engineering	Degree	1
			HND	1
			Diploma	1
		Relevant experience	Above 5 years	1
0-5 years			0	
<b>5</b>	<b>PLANT AND EQUIPMENT</b>		<b>Max 35</b>	
	Relevant Equipment (As Detailed in Schedule D)	Owned (Max 35marks)	0-35	
		100% Leased (Max 15 marks)	0-15	
<b>6</b>	<b>PROGRAM OF WORKS AND WORK METHODOLOGY</b>		<b>Max 13</b>	
6a	Work Methodology	Provided a detailed Work Methodology	0-3	
		Provided a Methodology on safety during the construction period	0-2	
		Provided a specific Quality management plan	0-2	
6b	Program of Works	PoW Resourced with Equipment-Min. allocation pursuant to the Schedule E of Technical Proposal - -- To be submitted in A3 Size Paper well legible Fonts	0-2	
		PoW captures Monthly outputs for each activity	0-1	
		PoW details BoQ Quantities, Units and Rates	0-1	
		PoW is superimposed with Cashflow Projections as detailed in Schedule A of the technical proposal	0-1	
<b>7</b>	<b>Organization and staffing</b> (Schedule B of Technical proposal) Equivalent of Site Base facilities		0-1	
	<b>TOTAL</b>		<b>MAX 100</b>	

## **SECTION V - TENDERING FORMS**

- 1. TENDERER'S QUALIFICATION FORMS**
  - Form ELI-1.1- Tenderer Information Form**
  - Form ELI- 1.2- Tenderer JV information**
  - Form ELI - 1.3- Qualification of Foreign Contractors**
  - Form ELI - 1.4- Declarations of materials, equipment and labor sources**
- 2. FORM OF TENDER**
  - A. TENDERER'S ELIGIBILITY - CONFIDENTIAL BUSINESS QUESTIONNAIRE**
  - B. CERTIFICATE OF INDEPENDENT TENDER DETERMINATION**
  - C. SELF-DECLARATION FORMS**
    - FORM SD1**
    - FORM SD2**
    - FORM SD3**
- 3. APPENDIX TO FORM OF TENDER**
- 4. CONTRACTUAL FORMS**
  - FORM CON – 1**
  - FORM CON – 2**
  - FORM CON – 3**
- 5. FINANCIAL FORMS**
  - FORM FIN- 3 .1**
  - FORM FIN- 3.2**
  - FORM FIN- 3.3**
- 6. TECHNICAL EXPERIENCE**
  - FORM EXP - 4.1**
  - FORM EXP - 4.2 (A)**
  - FORM EXP - 4.2 (B)**
- 7. TECHNICAL PROPOSAL**
  - SCHEDULE A. Projected Cash Flow**
  - SCHEDULE B. Site Organizations**
  - SCHEDULE C. Subcontractors**
  - SCHEDULE D. Contractor's Equipment**
  - SCHEDULE E. Initial Tentative Program of Performance**
  - SCHEDULE F. Key Personnel Proposed**
  - SCHEDULE D. Schedule of Materials Basic Rates**
- 8. FORM OF TENDER SECURITY - DEMAND GUARANTEE**
- 9. FORM OF TENDER SECURITY (TENDER BOND)**
- 10. FORM OF TENDER-SECURING DECLARATION**
- 11. FORM OF DECLARATION OF FAIR EMPLOYMENT LAWS AND PRACTICES**
- 12. FORM OF DECLARATION OF CONTRACTS TERMINATED IN THE LAST THREE (3) YEARS**

# TENDERER'S QUALIFICATION FORMS

## FORM ELI-1.1- TENDERER INFORMATION FORM

<b>Form ELI-1.1</b>
<b>Tenderer Information Form</b>
Date: _____  Tender No. _____  Tender title: _____
Tenderer's name: .....
In case of Joint Venture (JV), name of each member:.....
Tenderer's actual or intended country of registration: <i>[indicate country of Constitution]</i>
Tenderer's actual or intended year of incorporation:
Tenderer's legal address [in country of registration]:
Tenderer's authorized representative information Name: Address: Telephone/Fax numbers: E-mail address:
1. Attached are copies of original documents of:  I. <i>Certificate of Incorporation and CR12</i> of the legal entity named above, in accordance with ITT 4.1.  II. <i>Copies of National Identification documents for Directors</i>  <input type="checkbox"/> In case of a JV, Form of intent to form JV or JV agreement, in accordance with ITT 4.1. <input type="checkbox"/> In case of a state-owned enterprise or institution, in accordance with ITT 4.7. documents establishing: <ul style="list-style-type: none"><li>• Legal and financial autonomy</li><li>• Operation under commercial law</li><li>• Establishing that tenderer is not under the supervision of the Procuring Entity,</li></ul>
2. Included are the organizational chart, a list of Board of Directors, and the beneficial ownership ( <i>Applicable</i> ).

**FORM ELI- 1.2- TENDERER JV INFORMATION**

Tenderer's JV Information Form

(to be completed for each member of Tenderer's JV)

Date: \_\_\_\_\_

Tender No. \_\_\_\_\_

Tender title: \_\_\_\_\_

Tenderer's JV name:
JV member's name:
JV member's country of registration:
JV member's year of constitution:
JV member's legal address in country of constitution:
JV member's authorized representative information Name: _____ Address: _____ Telephone/Fax numbers: _____ E-mail address: _____
1. Attached are copies of original documents of: <ul style="list-style-type: none"><li>i. Certificate of Incorporation and CR 12 of the legal entity named above, including Registered JV agreement (Registration of Documents Act) , in accordance with ITT 4.1.</li><li>ii. Copies of National Identification documents for all Directors</li></ul> <input type="checkbox"/> In case of a state-owned enterprise or institution, documents establishing legal and financial autonomy, operation in accordance with commercial law, and that they are not under the supervision of the Procuring Entity, in accordance with ITT 4.7.
2. Included are the organizational chart, a list of Board of Directors, and the beneficial ownership ( <i>Applicable</i> ).

## FORM ELI - 1.3- QUALIFICATION OF FOREIGN CONTRACTORS

### Qualification of Foreign Tenderers

Pursuant to ITT 4.10, a foreign tenderer must complete this form to demonstrate that the tender fulfils this condition (the 40% Rule).

ITEM	Description of Work Item	Describe location of source	COST in K. shillings	Comments, if any
<b>A</b>	<b>Local Labour</b>			
1				
2				
3				
4				
5				
<b>B</b>	<b>Sub contracts from Local sources</b>			
1				
2				
3				
4				
5				
<b>C</b>	<b>Local materials</b>			
1				
2				
3				
4				
5				
<b>D</b>	<b>Use of Local Plant and Equipment</b>			
1				
2				
3				
4				
5				
<b>E</b>	<b>Add any other items</b>			
1				

2				
3				
4				
5				
6				
7				
	TOTAL COST LOCAL CONTENT		xx	
	PERCENTAGE OF CONTRACT PRICE		xx	

## FORM ELI - 1.4- DECLARATIONS OF MATERIALS, EQUIPMENT AND LABOUR SOURCES

Pursuant to ITT 5.1, tenderers must complete this form to demonstrate that the tender fulfils this condition

ITEM	Description of Work Item	Describe location of source	Comments, if any
<b>A</b>	<b>Materials</b>		
1			
2			
3			
4			
5			
6			
<b>B</b>	<b>Equipment</b>		
1			
2			
3			
4			
5			
<b>C</b>	<b>Labour</b>		
1			
2			
3			
4			
5			
6			
	TOTAL COST LOCAL CONTENT		
	PERCENTAGE OF CONTRACT PRICE		

## FORM OF TENDER

### INSTRUCTIONS TO TENDERERS

- (i) The Tenderer must prepare this Form of Tender on stationery with its letterhead clearly showing the Tenderer's complete name and business address.
  - (ii) All italicized text is to help Tenderer in preparing this form.
  - (iii) Tenderer must complete and sign and TENDERER'S ELIGIBILITY- CONFIDENTIAL BUSINESS QUESTIONNAIRE, CERTIFICATE OF INDEPENDENT TENDER DETERMINATION and the SELF DECLARATION OF THE TENDERER, all attached to this Form of Tender.
- i) The Form of Tender shall include the following Forms duly completed and signed by the Tenderer.
- A) Tenderer's Eligibility- Confidential Business Questionnaire
  - B) Certificate of Independent Tender Determination
  - C) Self-Declaration of the Tenderer

### FORM OF TENDER

Date of this Tender submission: *[insert date (as day, month and year) of Tender submission]*

Invitation to Tender No.: *[insert identification]* Alternative No.: *[Not Applicable]*

To:

---

We, the undersigned, declare that:

- a) *No reservations:* We have examined and have no reservations to the tendering document, including Addenda issued in accordance with Instructions to Tenderers (ITT) ;
- b) *Eligibility:* We meet the eligibility requirements and have no conflict of interest in accordance with ITT4;
- c) *Tender-Securing Declaration:* We have not been suspended nor declared ineligible by the Procuring Entity based on execution of a Tender-Securing Declaration or Proposal-Securing Declaration in Kenya in accordance with ITT 4.8.
- d) *Conformity:* We offer to execute in conformity with the tendering document and in accordance with the construction or service schedule the following Works:  
*[Tender Number and Name]*
- e) *Tender Price:* The total price of our Tender is [name of currency] (*amount in figures and words*).

- f) *Combined Price:* We hereby confirm that our combined price for Rehabilitation Works and Improvement Works does not exceed the threshold given in the TDS ITT 37.5, which is **[NOT APPLICABLE]**.
- g) *Tender Validity Period:* Our Tender shall be valid for a period specified in TDS 18.1 (or as amended if applicable) from the date fixed for the Tender submission deadline specified in TDS 22.1 (or as amended if applicable), and it shall remain binding upon us and may be accepted at any time before the expiration of that period;
- h) *Performance Security:* If our Tender is accepted, we commit to obtain a Performance Security in accordance with the tendering document;
- i) *One Tender per Tenderer:* We are not submitting any other Tender (s) as an individual Tenderer, and we are not participating in any other Tender(s) as a Joint Venture member or as a subcontractor, and meet the requirements of ITT 4.4, other than alternative Tenders submitted in accordance with ITT 13;
- a) *Suspension and Debarment:* We, along with any of our subcontractors, suppliers, consultants, manufacturers, or service providers for any part of the contract, are not subject to, and not controlled by any entity or individual that is subject to, a temporary suspension or a debarment imposed by the Procuring Entity. Further, we are not ineligible under Kenya laws or official regulations or pursuant to a decision of the United Nations Security Council;
- b) *State-owned enterprise or institution:* [select the appropriate option and delete the other] [We are not a state-owned enterprise or institution] / [We are a state-owned enterprise or institution but meet the requirements of ITT 4.7];
- c) *Commissions, gratuities and fees:* We have paid, or will pay the following commissions, gratuities, or fees with respect to the Tendering process or execution of the Contract: [insert complete name of each Recipient, its full address, the reason for which each commission or gratuity was paid and the amount and currency of each such commission or gratuity].

Name of Recipient	Address	Reason	Amount

(If none has been paid or is to be paid, indicate “none.”).

- d) *Binding Contract:* We understand that this Tender, together with your written acceptance thereof included in your Form of Acceptance, shall constitute a binding contract between us, until a formal contract is prepared and executed;
- e) *Not Bound to Accept:* We understand that you are not bound to accept the lowest evaluated cost Tender, the Best Evaluated Tender or any other Tender that you may receive;
- f) *Fraud and Corruption:* We hereby certify that we have taken steps to ensure that no person acting for us or on our behalf engages in any type of Fraud and Corruption;
- g) *Collusive practices:* We hereby certify and confirm that the tender is genuine, non-collusive and made with the intention of accepting the contract if awarded. To this effect we have signed the “Certificate of Independent Tender Determination” attached below.
- r) We undertake to adhere by the Code of Ethics for Persons Participating in Public Procurement and Asset Disposal, copy available from [www.ppra.go.ke](http://www.ppra.go.ke) during the procurement process and the execution of any resulting contract.
- s) We, the Tenderer, have completed fully and signed the following Forms as part of our Tender:
- a) Tenderer's Eligibility; Confidential Business Questionnaire – to establish we are not in any conflict to interest.
- b) Certificate of Independent Tender Determination – to declare that we completed the tender without colluding with other tenderers.
- a) Self-Declaration of the Tenderer – to declare that we will, if awarded a contract, not engage in

any form of fraud and corruption.

- b) Declaration and commitment to the Code of Ethics for Persons Participating in Public Procurement and Asset Disposal.
- t) Further, we confirm that we have read and understood the full content and scope of fraud and corruption as informed in "Appendix 1- Fraud and Corruption" attached to the Form of Tender.

Name of the Tenderer: \*[insert complete name of person signing the Tender]

Name of the person duly authorized to sign the Tender on behalf of the Tenderer: \*\*[insert complete name of person duly authorized to sign the Tender]

Title of the person signing the Tender: [insert complete title of the person signing the Tender]

Signature of the person named above: [insert signature of person whose name and capacity are shown above]

Date signed [insert date of signing] day of [insert month], [insert year]

Name in the capacity of \_\_\_\_\_

Signed

Duly authorized to sign the Tender for and on behalf of

Dated on \_\_\_\_\_ day of \_\_\_\_\_, \_\_\_\_\_

## A. TENDERER'S ELIGIBILITY - CONFIDENTIAL BUSINESS QUESTIONNAIRE

### Instruction to Tenderer

Tender is instructed to complete the particulars required in this Form, one form for each entity if Tender is a JV. Tenderer is further reminded that it is an offence to give false information on this Form.

#### a) Tenderer's details

	ITEM	
1	Name of Procuring Entity	Kenya National Highways Authority
2	Reference Number of the Tender	
3	Date and Time of Tender Opening	
4	Name of Tenderer	
5	Full Address and Contact Details of the Tenderer	1. Country 2. City 3. Location 4. Building 5. Floor 6. Postal Address 7. Name and email of contact person
6	Current Trade License Registration Number and Expiring date	
	Name, country and full address (postal and physical addresses, email, and telephone number) of Registering Body/Agency	
7	Description of Nature of Business	
8	Maximum value of business which the Tenderer handles	
9	State if Tenders Company is listed in stock exchange, give name and full address ( <i>postal and physical addresses, email, and telephone number</i> ) of state which stock exchange	

**General and Specific Details**

b) Sole Proprietor, provide the following details

Name in full \_\_\_\_\_ Age \_\_\_\_\_

Nationality \_\_\_\_\_ Country of Origin \_\_\_\_\_

Citizenship \_\_\_\_\_

c) Partnership, provide the following details.

	<b>Name of Partners</b>	<b>Nationality</b>	<b>Citizenship</b>	<b>%Shares Owned</b>
1				
2				
3				

(d) Registered Company, provide the following details.

i) Private or public Company \_\_\_\_\_

ii) State the nominal and issued capital of the Company-

Nominal Kenya Shillings (Equivalent).....

Issued Kenya Shillings (Equivalent).....

iii) Give details of Directors as follows.

	<b>Name of Directors</b>	<b>Nationality</b>	<b>Citizenship</b>	<b>%Shares Owned</b>
1				
2				
3				

e) DISCLOSURE OF INTEREST - Interest of the Firm in the Procuring Entity.

i) Are there any person/persons in..... (Name of Procuring Entity) who has/have an interest or relationship in this firm? Yes/No.....

If yes, provide details as follows.

	<b>Name of Person</b>	<b>Designation in the Procuring Entity</b>	<b>Interest or Relationship with Tenderer</b>
1			
2			
3			

ii) Conflict of interest disclosure

	<b>Type of Conflict</b>	<b>Disclosure YES or NO</b>	<b>If YES provide details of the relationship with Tenderer</b>
1	Tenderer is directly or indirectly controls, is controlled or is under common control with another tenderer.		
2	Tenderer receives or has received any direct or indirect subsidy from another tenderer.		
3	Tenderer has the same legal representative as another tenderer		
4	Tender has a relationship with another tenderer, directly or through common third parties, that puts it in a position to influence the tender of another tenderer, or influence the decisions of the Procuring Entity regarding this tendering process		
5	Any of the Tenderer's affiliates participated as a consultant in the preparation of the design or technical specifications of the works that are the subject of the tender.		
6	Tenderer would be providing goods, works, non-consulting services or consulting services during implementation of the contract specified in this Tender Document.		
7	Tenderer has a close business or family relationship with a professional staff of the Procuring Entity who are directly or indirectly involved in the preparation of the Tender document or specifications of the Contract, and/or the Tender evaluation process of such contract.		
8	Tenderer has a close business or family relationship with a professional staff of the Procuring Entity who would be involved in the implementation or supervision of the such Contract.		
9	Has the conflict stemming from such relationship stated in item 7 and 8 above been resolved in a manner acceptable to the Procuring Entity throughout the tendering process and execution of the Contract.		

f) Certification

On behalf of the Tenderer, I certify that the information given above is complete, current and accurate as at the date of submission.

Full Name\_\_\_\_\_

Title or Designation\_\_\_\_\_

\_\_\_\_\_  
(Signature) (Date)

## B. CERTIFICATE OF INDEPENDENT TENDER DETERMINATION

I, the undersigned, in submitting the accompanying Letter of Tender to the KENYA NATIONAL HIGHWAYS  
AUTHORITY for: \_\_\_\_\_ [Name of tender]  
\_\_\_\_\_ [ Tender number]

in response to the request for tenders made by: \_\_\_\_\_ [Name of Tenderer]

do hereby make the following statements that I certify to be true and complete in every respect:

I certify, on behalf of \_\_\_\_\_ [Name of Tenderer] that:

1. I have read and I understand the contents of this Certificate;
2. I understand that the Tender will be disqualified if this Certificate is found not to be true and complete in every respect;
3. I am the authorized representative of the Tenderer with authority to sign this Certificate, and to submit the Tender on behalf of the Tenderer;
4. For the purposes of this Certificate and the Tender, I understand that the word “competitor” shall include any individual or organization, other than the Tenderer, whether or not affiliated with the Tenderer, who:
  - a) Has been requested to submit a Tender in response to this request for tenders;
  - b) could potentially submit a tender in response to this request for tenders, based on their qualifications, abilities or experience;
5. The Tenderer discloses that [tick one of the following, as applicable]:
  - a) The Tenderer has arrived at the Tender independently from, and without consultation, communication, agreement or arrangement with, any competitor;
  - b) the Tenderer has entered into consultations, communications, agreements or arrangements with one or more competitors regarding this request for tenders, and the Tenderer discloses, in the attached document(s), complete details thereof, including the names of the competitors and the nature of, and reasons for, such consultations, communications, agreements or arrangements;
6. In particular, without limiting the generality of paragraphs (5) (a) or (5) (b) above, there has been no consultation, communication, agreement or arrangement with any competitor regarding:
  - a) prices;
  - b) methods, factors or formulas used to calculate prices;
  - c) the intention or decision to submit, or not to submit, a tender; or
  - d) the submission of a tender which does not meet the specifications of the request for Tenders; except as specifically disclosed pursuant to paragraph (5) (b) above;
7. In addition, there has been no consultation, communication, agreement or arrangement with any competitor regarding the quality, quantity, specifications or delivery particulars of the works or services to which this request for tenders relates, except as specifically authorized by the procuring authority or as specifically disclosed pursuant to paragraph (5) (b) above;
8. the terms of the Tender have not been, and will not be, knowingly disclosed by the Tenderer, directly or indirectly, to any competitor, prior to the date and time of the official tender opening, or of the awarding of the Contract, whichever comes first, unless otherwise required by law or as specifically disclosed pursuant to paragraph (5) (b) above.

Name and Title \_\_\_\_\_

Date \_\_\_\_\_

*[Name, title and signature of authorized agent of Tenderer and Date]*

**C. SELF-DECLARATION FORMS**

**FORM SD 1: SELF DECLARATION THAT THE PERSON/TENDERER IS NOT DEBARRED  
IN THE MATTER OF THE PUBLIC PROCUREMENT AND ASSET DISPOSAL ACT 2015**

I, ....., of Post Office Box.....being a resident of  
.....in the Republic of.....do hereby make a statement as follows: -

1. THAT I am the Company Secretary/ Chief Executive/Managing Director/Principal Officer/Director of  
..... (*insert name of the Company*) who is a Bidder in respect of Tender  
No.....for.....(*insert tender  
title/description*) for..... (*insert name of the Procuring entity*) and duly  
authorized and competent to make this statement.
2. THAT the aforesaid Bidder, its Directors and subcontractors have not been debarred from participating in  
procurement proceeding under Part IV of the Act.
3. THAT what is deponed to herein above is true to the best of my knowledge, information and belief.

.....  
(Title) (Signature) (Date)

Bidder Official Stamp

**FORM SD 2: SELF DECLARATION THAT THE TENDERER WILL NOT ENGAGE IN ANY CORRUPT OR FRAUDULENT PRACTICE**

I .....of P. O. Box.....being a resident of .....in the Republic of.....do hereby make a statement as follows: -

1. THAT I am the Chief Executive/Managing Director/Principal Officer/Director of.....  
..... (insert name of the Company) who is a Bidder in respect of Tender No.  
..... for ..... (*insert tender title/description*) for ..... (*insert name of the Procuring entity*) and duly authorized and competent to make this statement.
2. THAT the aforesaid Bidder, its servants and/or agents /subcontractors will not engage in any corrupt or fraudulent practice and has not been requested to pay any inducement to any member of the Board, Management, Staff and/or employees and/or agents of ..... (*insert name of the Procuring entity*) which is the procuring entity.
3. THAT the aforesaid Bidder, its servants and/or agents /subcontractors have not offered any inducement to any member of the Board, Management, Staff and/or employees and/or agents of..... (*name of the procuring entity*).
4. THAT the aforesaid Bidder will not engage/has not engaged in any corrosive practice with other bidders participating in the subject tender
5. THAT what is deponed to herein above is true to the best of my knowledge information and belief.

.....  
(Title) (Signature) (Date)

Bidder's Official Stamp

**FORM SD 3: DECLARATION AND COMMITMENT TO THE CODE OF ETHICS**

I, ..... (person) on behalf of (Name of the Business/Company/Firm) .....declare that I have read and fully understood the contents of the Public Procurement & Asset Disposal Act, 2015, Regulations and the Code of Ethics for persons participating in Public Procurement and Asset Disposal and my responsibilities under the Code.

I do hereby commit to abide by the provisions of the Code of Ethics for persons participating in Public Procurement and Asset Disposal.

Name of Authorized signatory.....

Sign.....

Position.....

Office address.....Telephone.....

E-mail.....

Name of the

Firm/Company.....

Date.....

*(Company Seal/ Rubber Stamp where applicable)*

Witness

Name.....

Sign.....

Date.....

## APPENDIX 1-FRAUD AND CORRUPTION

*(Appendix 1 shall not be modified)*

### 1. Purpose

- 1.1 The Government of Kenya's Anti-Corruption and Economic Crime laws and their sanction's policies and procedures, Public Procurement and Asset Disposal Act (*no. 33 of 2015*) and its Regulation, and any other Kenya's Acts or Regulations related to Fraud and Corruption, and similar offences, shall apply with respect to Public Procurement Processes and Contracts that are governed by the laws of Kenya.

### 2. Requirements

- 1.2 The Government of Kenya requires that all parties including Procuring Entities, Tenderers, (applicants/proposers), Consultants, Contractors and Suppliers; any Sub-contractors, Sub-consultants, Service providers or Suppliers; any Agents (whether declared or not); and any of their Personnel, involved and engaged in procurement under Kenya's Laws and Regulation, observe the highest standard of ethics during the procurement process, selection and contract execution of all contracts, and refrain from Fraud and Corruption and fully comply with Kenya's laws and Regulations as per paragraphs 1.1 above.
- 1.3 Kenya's public procurement and asset disposal act (*no. 33 of 2015*) under Section 66 describes rules to be followed and actions to be taken in dealing with Corrupt, Coercive, Obstructive, Collusive or Fraudulent practices, and Conflicts of Interest in procurement including consequences for offences committed. A few of the provisions noted below highlight Kenya's policy of no tolerance for such practices and behavior:
  - 1) a person to whom this Act applies shall not be involved in any corrupt, coercive, obstructive, collusive or fraudulent practice; or conflicts of interest in any procurement or asset disposal proceeding;
  - 2) A person referred to under subsection (1) who contravenes the provisions of that sub-section commits an offence;
  - 3) Without limiting the generality of the subsection (1) and (2), the person shall be—
    - a) disqualified from entering into a contract for a procurement or asset disposal proceeding; or
    - b) if a contract has already been entered into with the person, the contract shall be voidable;
  - 4) The voiding of a contract by the procuring entity under subsection (7) does not limit any legal remedy the procuring entity may have;
  - 5) An employee or agent of the procuring entity or a member of the Board or committee of the procuring entity who has a conflict of interest with respect to a procurement—
    - a) shall not take part in the procurement proceedings;
    - b) shall not, after a procurement contract has been entered into, take part in any decision relating to the procurement or contract; and
    - c) shall not be a subcontractor for the bidder to whom was awarded contract, or a member of the group of bidders to whom the contract was awarded, but the subcontractor appointed shall meet all the requirements of this Act.
  - 6) An employee, agent or member described in subsection (1) who refrains from doing anything prohibited under that subsection, but for that subsection, would have been within

his or her duties shall disclose the conflict of interest to the procuring entity;

- 7) If a person contravenes subsection (1) with respect to a conflict of interest described in subsection (5) (a) and the contract is awarded to the person or his relative or to another person in whom one of them had a director indirect pecuniary interest, the contract shall be terminated and all costs incurred by the public entity shall be made good by the awarding officer. Etc.

1.4 In compliance with Kenya's laws, regulations and policies mentioned above, the Procuring Entity:

- i) Defines broadly, for the purposes of the above provisions, the terms set forth below as follows: "corrupt practice" is the offering, giving, receiving, or soliciting, directly or indirectly, of anything of value to influence improperly the actions of another party;
- ii) "fraudulent practice" is any act or omission, including misrepresentation, that knowingly or recklessly misleads, or attempts to mislead, a party to obtain financial or other benefit or to avoid an obligation;
- iii) "collusive practice" is an arrangement between two or more parties designed to achieve an improper purpose, including to influence improperly the actions of another party;
- iv) "coercive practice" is impairing or harming, or threatening to impair or harm, directly or indirectly, any party or the property of the party to influence improperly the actions of a party;
- v) "obstructive practice" is:
  - deliberately destroying, falsifying, altering, or concealing of evidence material to the investigation or making false statements to investigators in order to materially impede investigation by Public Procurement Regulatory Authority (PPRA) or any other appropriate authority appointed by Government of Kenya into allegations of a corrupt, fraudulent, coercive, or collusive practice; and/or threatening, harassing, or intimidating any party to prevent it from disclosing its knowledge of matters relevant to the investigation or from pursuing the investigation; or
  - acts intended to materially impede the exercise of the PPRA's or the appointed authority's inspection and audit rights provided for under paragraph 2.3 e. below.
- b) Defines more specifically, in accordance with the above procurement Act provisions set forth for fraudulent and collusive practices as follows:

"fraudulent practice" includes a misrepresentation of fact in order to influence a procurement or disposal process or the exercise of a contract to the detriment of the procuring entity or the tenderer or the contractor, and includes collusive practices amongst tenderers prior to or after tender submission designed to establish tender prices at artificial non-competitive levels and to deprive the procuring entity of the benefits of free and open competition.

- c) Rejects a proposal for award<sup>1</sup> of a contract if PPRA determines that the firm or individual recommended for award, any of its personnel, or its agents, or its sub-consultants, sub-contractors, service providers, suppliers and/ or their employees, has, directly or indirectly, engaged in corrupt, fraudulent, collusive, coercive, or obstructive practices in competing for the contract in question;
- d) Pursuant to the Kenya's above stated Acts and Regulations, may sanction or recommend to appropriate authority(ies) for sanctioning and debarment of a firm or individual, as applicable under the Acts and Regulations;
- e) Requires that a clause be included in Tender documents and Request for Proposal documents requiring (i) Tenderers (applicants/proposers), Consultants, Contractors, and Suppliers, and their Sub-contractors, Sub- consultants, Service providers, Suppliers, Agents personnel,

permit the PPRA or any other appropriate authority appointed by Government of Kenya to inspect<sup>2</sup> all accounts, records and other documents relating to the procurement process, selection and/or contract execution, and to have them audited by auditors appointed by the PPRA or any other appropriate authority appointed by Government of Kenya; and

- f) Pursuant to Section 62 of the above Act, requires Applicants/Tenderers to submit along with their Applications/Tenders/Proposals a “Self-Declaration Form” as included in the procurement document declaring that they and all parties involved in the procurement process and contract execution have not engaged/will not engage in any corrupt or fraudulent practices.

---

<sup>1</sup> For the avoidance of doubt, a party's ineligibility to be awarded a contract shall include, without limitation, (i) applying for pre-qualification, expressing interest in a consultancy, and tendering, either directly or as a nominated sub-contractor, nominated consultant, nominated manufacturer or supplier, or nominated service provider, in respect of such contract, and (ii) entering into an addendum or amendment introducing a material modification to any existing contract.

<sup>2</sup> Inspections in this context usually are investigative (i.e., forensic) in nature. They involve fact-finding activities undertaken by the Investigating Authority or persons appointed by the Procuring Entity to address specific matters related to investigations/audits, such as evaluating the veracity of an allegation of possible Fraud and Corruption, through the appropriate mechanisms. Such activity includes but is not limited to: accessing and examining a firm's or individual's financial records and information, and making copies thereof as relevant; accessing and examining any other documents, data and information (whether in hard copy or electronic format) deemed relevant for the investigation/audit, and making copies thereof as relevant; interviewing staff and other relevant individuals; performing physical inspections and site visits; and obtaining third party verification of information.

**APPENDIX TO FORM OF TENDER**

**(This appendix forms part of the bid)**

<b>CONDITIONS OF CONTRACT</b>	<b>CLAUSE</b>	<b>AMOUNT/DESCRIPTION</b>
Tender Security	ITT 19.1	Kshs 300,000.00 (Three Hundred Thousand Kenya Shillings)
Amount of Performance Security (Unconditional Bank Guarantee)	10.1	5% of Tender Sum in the form of Unconditional Bank Guarantee
Program to be submitted	14.1	Not later than Fourteen (14) days after issuance of Order to Commence in the format Prescribed in the Tender Document
Cash flow estimate to be submitted	14.3	Not later than Fourteen (14) days after issuance of Order to Commence
Payment of Monthly Salaries/allowances to Contractor's employees and allowances to due to all officers seconded by the Engineer to the assignment.	16.1	Monthly Payment to be made on or before the last day of the month. Any delays shall attract a penalty of <b>KSh. 50,000.00</b> per day for the period salaries/allowances are delayed.
Penalty for not implementing approved Safety Plan.	19.1	Upto Kshs. 50, 000.00 per day
Scope of Insurance Policy Cover	22.1	Furnish the Engineer with a copy of Insurance Policy of WIBA not later than Fourteen (14) days after issuance of Order to Commence
Minimum amount of Contractor's All risk Insurance	23.2	Contract Price
Road Safety Implementation Plan	19.1	Not later than Fourteen (14) days after issuance of Order to Commence
Period for commencement, from Engineer's order to commence	41.1	14 days
Time for completion of works	43.1	Eighteen (18) Months
Contract Period	43.	Twenty-Four (24) Months
Defects Liability period for Works	49.1	Six (6) Months
Period of Contract Validity	60.6	From contract signing up to the date of settlement of the agreed final statement issued pursuant to clause 60.6.
Advance Payment	60.12	N/A
Advance Payment Security	60.12	N/A
Amount of liquidated damages	47.1	0.05% of Contract Price per day

<b>CONDITIONS OF CONTRACT</b>	<b>CLAUSE</b>	<b>AMOUNT/DESCRIPTION</b>
Limit of liquidated damages	47.1	5% of Contract Price
Damages for not attending to excavated potholes within 48 hours of excavation	47.1(b)	KShs. 50, 000.00 per month per pothole
Percentage of Retention	60.3	5% of Interim Payment Certificate
Limit of Retention Money	60.3	5% of Contract Price
Minimum Amount of interim certificates	60.2	5% of Contract Price
Time within which payment to be made after Interim Payment Certificate signed by Engineer	60.10	90 days
Time within which payment to be made after Final Payment Certificate signed by Engineer	60.10	90 days
Time to commence price adjustment (Variation of Prices)	70.1	N/A
Appointer of Adjudicator	67.3	The Chartered Institute of Arbitrators (Kenya)



**FORM CON – 1 HISTORICAL CONTRACT NON-PERFORMANCE, PENDING LITIGATION AND LITIGATION HISTORY**

Tenderer's Name: \_\_\_\_\_ Date: \_\_\_\_\_

JV Member's Name \_\_\_\_\_

Tender No. \_\_\_\_\_

Tender title: \_\_\_\_\_

Non- Performed Contracts in accordance with Section III, Evaluation and Qualification Criteria			
<input type="checkbox"/> Contract non-performance did not occur for the last three (3) years from the day of tender opening. <input type="checkbox"/> Contract(s) not performed for the last three (3) years from the day of tender opening			
Year	Non-performed portion of contract	Contract Identification	Total Contract Amount (Kenya Shilling equivalent)
<i>[insert year]</i>	<i>[insert amount and percentage]</i>	Contract Identification: <i>[indicate complete contract name/number; and any other identification]</i>  Name of Procuring Entity: <i>[insert full name]</i>  Address of Procuring Entity: <i>[insert street/city/country]</i>  Reason(s) for nonperformance: <i>[indicate main reason(s)]</i>	<i>[insert amount]</i>
Pending Litigation, in accordance with Section III, Qualification Criteria and Requirements			
<input type="checkbox"/> No pending litigation in accordance with Section III, Qualification Criteria and Requirements, Sub-Factor 8. <input type="checkbox"/> Pending Litigation in accordance with Section III, Evaluation and Qualification Criteria, Sub-Factor 9 as indicated below			
Year of dispute	Amount in dispute (currency)	Contract Identification	Total Contract Amount (Kenya Shilling equivalent)
		Contract Identification: Name of Procuring Entity: Address of Procuring Entity: Matter in dispute: Party who initiated the dispute: Status of dispute:	
Litigation History in accordance with Section III, Evaluation and Qualification Criteria			
<input type="checkbox"/> No Litigation History in accordance with Section III, Evaluation and Qualification Criteria, Sub-Factor 2.4. <input type="checkbox"/> Litigation History in accordance with Section III, Evaluation and Qualification Criteria, Sub-Factor 2.4 as indicated below			
Year of award	Outcome as percentage of Net Worth	Contract Identification	Total Contract Amount (Kenya Shilling equivalent)



**FORM CON – 3: CERTIFICATE OF BIDDER’S VISIT TO SITE**

This is to certify that

[Name/s].....

Being the authorized representative/Agent of [Name of bidder]

.....

.....

Participated in the organized inspection visit of the site of the works for the

**PERIODIC MAINTENANCE OF KAMPI YA MOTO - EMINING (B17) ROAD**

Held on.....day of.....20.....

Signed.....

(Employer’s Representative)

.....

.....

(Name of Employer’s Representative)

.....

(Designation)

NOTE: This form is to be completed at the time of the organized site visit.

## FORM FIN – 3.1: FINANCIAL SITUATION AND PERFORMANCE

### PART 1

Tenderer's Name: \_\_\_\_\_ Date: \_\_\_\_\_

JV Member's Name \_\_\_\_\_

Tender No. \_\_\_\_\_

Tender title: \_\_\_\_\_

#### 1. Financial data

Type of Financial information (Kenya Shillings)	Historic information for previous <u>3</u> years, (amount in Millions (KSh.))		
	2020	2021	2022
Statement of Financial Position (Information from Balance Sheet)			
Total Assets (TA)			
Total Liabilities (TL)			
Total Equity/Net Worth (NW)			
Current Assets (CA)			
Current Liabilities (CL)			
Working Capital (WC)			
Information from Income Statement			
Total Revenue (TR)			
Profits Before Taxes (PBT)			
Cash Flow Information			
Cash Flow from Operating Activities			

## 2. Sources of Finance

Specify sources of finance to meet the cash flow requirements on works currently in progress and for future contract commitments.

No.	Source of finance	Amount (Kenya Shilling equivalent)
1	Letter of line of Credit from a recognized Financial Institution	
2	Bank account balance (demonstrated by bank statements)	

## 3. Financial documents

The Tenderer and its parties shall provide copies of financial statements for the last *three (3)* years pursuant Section III, Evaluation and Qualifications Criteria, Sub-factor 3.1. The financial statements shall:

- a) Reflect the financial situation of the Tenderer or in case of JV member, and not an affiliated entity (such as parent company or group member).
- b) Be independently audited or certified in accordance with local legislation.
- c) Be complete, including all notes to the financial statements.
- d) Correspond to accounting periods already completed and audited.

Attached are copies of financial statements for the Three (3) years required above; and complying with the requirements

**PART 2**

**Detailed Financial Situation Evaluation**

No.	Description	Auditors Assessment 2020	Auditors Assessment 2021	Auditors Assessment 2022	Evaluation Score Award Criteria
1.	Financial Ratios				Max score=4 Marks
a.	<b>Current Ratio=</b> <b><u>Current Assets</u></b> <b>Current Liabilities</b>				Current Ratio more than 1 = 1 marks
b.	<b>Debt to Equity Ratio =</b> <b><u>Total Liabilities</u></b> <b>Total Equity</b>				Equity Capital Ratio less than 1 = 1 Marks
c.	<b>Working Capital =</b> <b>Current Assets-</b> <b>Current Liabilities</b>				Positive Working Capital = 1 marks
d.	<b>Operating Cash Flow Ratio =</b> <b>Cash Flow from</b> <b><u>Operations</u></b> <b>Current Liabilities</b>				Operating Cash-flow more than 1 = 1 marks
2.	<b>Working Capital in KShs.....</b>				Working Capital is equal or more than 10% of the bid price = 4 Marks

The above Financial Ratios have to be derived from first Principles from the Audit Statements. The Auditor who has undertaken the analysis has to demonstrate the financial ratios and append his signature and stamp to the Document as below:

The Auditor shall be required to provide his/her workings and demonstrate the source of the workings from the various Audited statements by including the Page Numbers and references of the source of the figures used in the computation of the assigned values.

**The Auditor undertaking the above Financial Analysis MUST duly fill the Contact Sheet below in all aspects and attach current annual practising license.**

**Financial ratios Computed by a Certified Public Accountant:**

<b>CPA: Name</b>	
<b>ICPAK Number</b>	
<b>Telephone Number</b>	
<b>Email Address</b>	
<b>Postal Address</b>	
<b>Physical Address</b>	
<b>Contact Person</b>	
<b>Mobile Contact of the Contact Person</b>	
<b>Signature</b>	
<b>Date</b>	
<b>Personal/Corporate Stamp</b>	

**Ratios attested by the Company Director:**

<b>Director's Name</b>	
<b>ID/Passport Number</b>	
<b>Telephone Number</b>	
<b>Email Address</b>	
<b>Postal Address</b>	
<b>Physical Address</b>	
<b>Signature</b>	
<b>Date</b>	
<b>Personal/Corporate Stamp</b>	

**FORM FIN – 3.2: AVERAGE ANNUAL CONSTRUCTION TURNOVER**

Tenderer's Name: \_\_\_\_\_

Date: \_\_\_\_\_

JV Member's Name \_\_\_\_\_

Tender No. \_\_\_\_\_

Tender title: \_\_\_\_\_

<b>Annual turnover data (construction only)</b>			
<b>Year</b>	<b>Amount Currency</b> <i>[insert amount and indicate currency]</i>	<b>Exchange Rate</b> <b>(where applicable)</b>	<b>Kenya Shilling equivalent</b>
2020			
2021			
2022			
Average Annual Construction Turnover*			

\* See Section III, Evaluation and Qualification Criteria.

*If the most recent set of financial statements is for a period earlier than 12 months from the date of Bid, the reason for this should be justified.*



**FORM EXP - 4.1: GENERAL CONSTRUCTION EXPERIENCE**

Tenderer's Name: \_\_\_\_\_

Date: \_\_\_\_\_

JV Member's Name \_\_\_\_\_

Tender No. \_\_\_\_\_

Tender title: \_\_\_\_\_

Starting Year	Ending Year	Contract Identification	Role of Tenderer
		Contract name:  Brief Description of the Works and Services performed by the Tenderer:  Amount of contract: Name of Procuring Entity: Address:	<i>Main Contractor/                      Subcontractor/                      Management                      Contractor</i>
		Contract name:  Brief Description of the Works and Services performed by the Tenderer:  Amount of contract: Name of Procuring Entity: Address:	
		Contract name:  Brief Description of the Works and Services performed by the Tenderer:  Amount of contract: Name of Procuring Entity: Address:	

**FORM EXP - 4.2(A): SPECIFIC CONSTRUCTION AND CONTRACT MANAGEMENT EXPERIENCE**

Tenderer's Name: \_\_\_\_\_

Date: \_\_\_\_\_

JV Member's Name \_\_\_\_\_

Tender No. \_\_\_\_\_

Tender title: \_\_\_\_\_

Similar Contract No..	Information			
Contract Identification				
Award date				
Completion date				
Role in Contract	Prime Contractor  <input type="checkbox"/>	Member in JV  <input type="checkbox"/>	Management Contractor  <input type="checkbox"/>	Sub-Contractor  <input type="checkbox"/>
Total Contract Amount			Kenya Shillings	
If member in a JV or sub-contractor, specify participation in total Contract amount				
Procuring Entity's Name:				
Address:  Telephone/fax number  E-mail:				
Description of the similarity in accordance with Sub-Factor 4.2(b) of Section III:				
1. Amount				
2. Physical size of required Works and Services items				
3. Complexity				
4. Methods/Technology				
5. Construction rate for key activities				
6. Other Characteristics				

**FORM EXP - 4.2(B): CONSTRUCTION EXPERIENCE IN KEY ACTIVITIES**

Tenderer's Name:

Date:

Tenderer's JV Member Name:

Sub-contractor's Name (as per ITT 33.2):

Tender No. \_\_\_\_\_

Tender title: \_\_\_\_\_

All Sub-contractors for key activities must complete the information in this form as per ITT 33.2 and Section III, Qualification Criteria and Requirements, Sub-Factor 4.2.

1. Key Activity No One: \_\_\_\_\_

	<b>Information</b>			
Contract Identification				
Award date				
Completion date				
Role in Contact	Prime Contractor <input type="checkbox"/>	Member in JV <input type="checkbox"/>	Management Contractor <input type="checkbox"/>	Sub-Contractor <input type="checkbox"/>
Total Contract Amount			Kenya Shillings	
Quantity (Volume, number or rate of production, as applicable) performed under the contract per year or part of the year	Total quantity in the contract (i)	Percentage participation (ii)	Actual Quantity Performed (i)*(ii)	
Year 1				
Year 2				
Year 3				
Year 4				
Procuring Entity's Name: Address: Telephone/fax number E-mail:				

Information	
Description of key activities in accordance with Sub-Factor 4.2(b) of Section III:	

*If applicable*

2 Activity No. Two

3. ....

## **TECHNICAL PROPOSAL**

The Tenderer's Technical Proposal shall include the following elements:

SCHEDULE A. Projected Cash Flow

SCHEDULE B. Site Organizations

SCHEDULE C. Subcontractors

SCHEDULE D. Contractor's Equipment

SCHEDULE E. Initial Tentative Program of Performance

SCHEDULE F. Key Personnel Proposed

Instructions on how to present the various schedules of the Technical Proposal are given on the following pages

## SCHEDULE A

### Projected Cash Flow

- 1) Tenderers shall tabulate below estimates, based on their preliminary work programme, of:
  - a) On the expenditure side, the value of the work which will be carried out;
  - b) On the revenue side, the net payments to which they will become entitled with due allowance for the advance payment and repayment, materials prepayments, and retention money, but excluding price adjustments for rise and fall and provisional sums for emergency works.
  - c) The projected net cash flow during the contract period.
- 2) The prospective successful Tenderer may be required to submit full details to substantiate his estimates.

Period (Months)	Cost of Routine Maintenance Works	Net Payment to be received	Net Cashflow
1-3			
3-6			
6-9			
9-12			
ETC			

## **SCHEDULE B**

### **Site Organization**

Tenderers shall give below full particulars of the organization they propose to establish, direct, and administer the performance of the Contract. In particular, Tenderers shall indicate the location of site camps and the resources they intend to allocate to Self-Control Units for planning and monitoring purposes.

1. SITE ORGANIZATION CHART
  - i. ORANOGRAM
  - ii. SITE ORGANISATION LAYOUTS
  - iii. SITE LOCATION MAP
2. NARRATIVE DESCRIPTION OF SITE ORGANIZATION CHART

## **SCHEDULE C**

### **SUB-CONTRACTORS / PARTNERS**

Tenderers shall list below those parts of the Works and Services which they propose to subcontract, and state the approximate value of those parts and the names and addresses of the proposed subcontractors, if those are known at Tendering stage. Tenderers shall also list other business partners involved in the execution of the contract and their respective roles and responsibilities.

Part of Works /  
Services:

Approximate  
value:

Name and address of proposed subcontractor / partner:

Part of Works /

Services:

Approximate  
value:

Name and address of proposed subcontractor / partner:

Part of Works /

Services:

Approximate  
value:

Name and address of proposed subcontractor / partner:

Part of Works /

Services:

Approximate  
value:

Name and address of proposed subcontractor / partner:

**SCHEDULE D**

**Contractor’s Equipment Form EQU**

The Tenderer shall provide adequate information to demonstrate clearly that it has the capability to meet the requirements for the key equipment listed in Section III, Evaluation and Qualification Criteria. A separate Form shall be prepared for each item of equipment listed in Section B (Technical Evaluation) of Qualification Form.

Equipment Information and current status for equipment leased from Government Agencies may be omitted

<b>Item of equipment</b>		
Equipment information	Name of manufacturer	Model and power rating
	Capacity	Year of manufacture
Current Status	Current Location:	
	Details of current commitments	
Source	Indicate source of equipment <input type="checkbox"/> Owned <input type="checkbox"/> Rented <input type="checkbox"/> Leased <input type="checkbox"/> Specially manufactured	

Omit the following information for equipment owned by the Tenderer.

Owner	Name of owner	
	Address of owner	
	Telephone	Contact name and title
	Fax	
Agreements	Details of rental/ lease/ manufacture agreements specific to the project	

## **SCHEDULE E**

### **Initial Tentative Program of Works**

To demonstrate a clear understanding of the requirements of the Contract, Tenderers shall provide the following:

- i) A bar chart sub-divided into sections for each road showing the major activities to be carried out for Maintenance Works. The activities shall be shown against time, with linkages shown between related/sequential activities as far as possible and appropriate.
- ii) A bar chart or schedule showing the usage of major plant, including those listed in Schedule D (Contractor's Equipment).

## SCHEDULE F

### Form PER -1 Key Personnel Schedule

Tenderers should provide the names and details of the suitably qualified Key Personnel to perform the Contract. The data on their experience should be supplied using the Form PER-2 below for each candidate.

#### Key Personnel

<b>1.</b>	<b>Title of position: Site Agent</b>	
	<b>Name of candidate:</b>	
	<b>Duration of appointment:</b>	<i>[insert the whole period (start and end dates) for which this position will be engaged]</i>
	<b>Time commitment for this position:</b>	<i>[insert the number of days/weeks/months that has been scheduled for this position]</i>
	<b>Expected time schedule for this position:</b>	<i>Full time site presence</i>
<b>2.</b>	<b>Title of position: Foreman</b>	
	<b>Name of candidate:</b>	
	<b>Duration of appointment:</b>	<i>[insert the whole period (start and end dates) for which this position will be engaged]</i>
	<b>Time commitment for this position:</b>	<i>[insert the number of days/weeks/months that has been scheduled for this position]</i>
	<b>Expected time schedule for this position:</b>	<i>Full time site presence</i>

Countersignature of authorized representative of the Tenderer:

Signature: \_\_\_\_\_

Date: (day month year): \_\_\_\_\_

**Form PER -2**

**Resume and Declaration – Key Personnel- (Resume to be provided in this format)**

<b>Name of Tenderer</b>
-------------------------

<b>Position [1]: [title of position from Form PER-1]</b>		
<b>Personnel information</b>	<b>Name:</b>	<b>Date of birth:</b>
	<b>Address:</b>	<b>E-mail:</b>
	<b>Professional qualifications:</b>	
	<b>Academic qualifications:</b>	
	<b>Language proficiency:</b> [language and levels of speaking, reading and writing skills]	
<b>Details</b>	<b>Address of Tendering Entity:</b>	
	<b>Telephone:</b>	<b>Contact (manager/personnel officer):</b>
	<b>Fax:</b>	
	<b>Job title:</b>	<b>Years with present Entity:</b>

Summarize professional experience in reverse chronological order. Indicate particular technical and managerial experience relevant to the project.

<b>Project</b>	<b>Role</b>	<b>Duration of involvement</b>	<b>Relevant experience</b>
<i>[main project details]</i>	<i>[role and responsibilities on the project]</i>	<i>[time in role]</i>	<i>[describe the experience relevant to this position]</i>

**Declaration**

I, the undersigned Key Personnel, certify that to the best of my knowledge and belief, the information contained in this Form PER -2 correctly describes myself, my qualifications and my experience.

I confirm that I am available as certified in the following table and throughout the expected time schedule for this position as provided in the Tender:

<b>Commitment</b>	<b>Details</b>
Commitment to duration of contract:	<i>[insert period (start and end dates) for which this Key Personnel is available to work on this contract]</i>
Time commitment:	<i>[insert the number of days/weeks/months that this Key Personnel will be engaged]</i>

I understand that any misrepresentation or omission in this Form may:

- a) be taken into consideration during Tender evaluation;
- b) my disqualification from participating in the Tender;
- c) my dismissal from the contract.

Name of Key Personnel: *[insert name]*

Signature: \_\_\_\_\_

Date: (day month year): \_\_\_\_\_

Countersignature of authorized representative of the Tenderer:

Signature: \_\_\_\_\_

Date: (day month year): \_\_\_\_\_

## SCHEDULE G

### PART I. SCHEDULE OF MATERIALS; -BASIC PRICES

ITEM NO	DESCRIPTION	NAME OF SUPPLIER	COUNTRY OF ORIGIN	UNIT	RATE	
					KSHS	CTS
1.	Cut-back Bitumen MC 30 in bulk			Litre		
2.	Cut-back Bitumen MC 30 in drums			Litre		
3.	Bitumen 80/100 in bulk			Kg		
4..	Bitumen 80/100 in drums			Kg		
5..	Bitumen Emulsion K1-60 in bulk			Litre		
6.	Bitumen Emulsion K1-60 in drums			Litre		
7.	Petrol, Regular Grade			Litre		
8.	Petrol, Premium/ super Grade			Litre		
9.	Automotive Diesel Fuel			Litre		
10.	Industrial Diesel Oil			Litre		
11.	Industrial Fuel Oil			Litre		
12.	Kerosene Fuel			Litre		
13.	Cement			Tonne		
14.	Flex beam Guardrail			Metre		
15.	Gabion Mesh			M <sup>2</sup>		
16.	Reinforcing Steel			Tonne		
17.	Lime			Tonne		

I certify that the above information is correct

.....  
(Title)

.....  
(Signature)

.....  
(Date)

#### Notes:

- The Base year for the indices shall be 2019.
- Prices of imported materials to be quoted CIF Mombasa or Nairobi as appropriate depending on whether materials are imported by the tenderer directly or through a local agent.

**PART II. SCHEDULE OF RATES DERIVATION**

*A Sample Schedule showing how it should be filled by bidder.*

**Form for Detailed Breakdown of Cost Comparison**

<b>Bill item No.</b>	16-80-001	
<b>Description</b>	Provide, lay and roll asphalt concrete type 1 (bitumen content 5-6% by weight) as pothole patching and regulation - hot mix.	
<b>Units</b>	M <sup>3</sup>	(Assumed production is 160m <sup>3</sup> per day)
<b>Quantity</b>	4,680	

**Rate build up**

a) Direct cost (DC)      i) Unit work Price

1) Material Cost

Description	Units	Quantity	Market Price	Amount
AC Type 1	M <sup>3</sup>	1	20,900.00	20,900.00
<b>Sub Total For Material</b>				<b>20,900.00</b>

2) Labour Price

Personnel	No. Required	Rate /day	Amount
Skilled Labour overseer	2	1,800.00	22.50
Skilled Labour - Operator	6	2,045.00	76.69
Artisans Grade II	12	1,612.00	120.90
Unskilled labour	15	873.00	81.84
<b>Sub Total For Labor</b>			<b>301.93</b>
Productivity ratio			

3) Machinery

Machinery type	No. Required	Rate /day	Amount	Hired/Owned
Roller	1	38,720.00	242.00	Hired
PTR	1	29,200.00	182.50	Hired
Air Compressor	1	9,625.00	60.16	Hired
Bitumen Sprayer H/Operated	1	4,400.00	27.50	Hired
AC Paver	1	50,504.00	315.65	Hired
<b>Sub Total for Machinery</b>			<b>827.81</b>	
Productivity ratio				

Sub-total of unit price	
Sum (1+2+3)	<b>22,029.74</b>

ii) Haulage Cost 

1,104.49
----------

Sub-totals of DC 

23,131.22
-----------

b) Indirect Cost 

2,313.12
----------

c) Overheads and Profits 

6,939.37
----------

**Total Cost**  
Sum (a+b+c)  
Forwarded to the BoQ (16-80-001) 

<b>32,383.71</b>
------------------

**Notes:**

- Attach current (atleast 30 days before tender opening date) proof of cost of materials e.g. Proforma Invoices/quotations.
- This form has been based on the principles of Cost Estimation Manual. The Cost Estimation Manual can be downloaded from the following website: <https://krb.go.ke/downloads>

I certify that the above information is correct.

.....  
(Title)

.....  
(Signature)

.....  
(Date & Official Stamp)

## Form for Detailed Breakdown of Cost Comparison

**Bill item No.**

15-50-002

**Description**

Provide and Spray MC 30 Cut Back bitumen as Prime coat to Carriage way shoulders, bus bays and junctions

**Units**

litre

**Quantity**

160,380

**Rate build up**

a) Direct cost (DC)

i) Unit work Price

1) Material Cost

Description	Units	Quantity	Market Price	Amount
<b>Sub Total For Material</b>				

2) Labour Price

Personnel	No. Required	Rate /day	Amount
<b>Sub Total For Labor</b>			
Productivity ratio			

3) Machinery

Machinery type	No. Required	Rate /day	Amount	Hired/Owned
<b>Sub Total for Machinery</b>				
Productivity ratio				

Sub-total of unit price

Sum (1+2+3)

ii) Haulage Cost

Sub-totals of DC

b) Indirect Cost

c) Overheads and Profits

**Total Cost**

Sum (a+b+c)

Forwarded to the BOQ  
(Bill no: 15-50-002)

**Notes:**

- Attach current (atleast 30 days before tender opening date) proof of cost of materials e.g. Proforma Invoices/quotations.
- The form shall be based on the principles of Cost Estimation Manual. The Cost Estimation Manual can be downloaded from the following website (<https://krb.go.ke/downloads>)

I certify that the above information is correct

.....  
(Title)

.....  
(Signature)

.....  
(Date& Official Stamp)

## Form for Detailed Breakdown of Cost Comparison

**Bill item No.**

15-60-004

**Description**

Provide, spread and roll 10/40 mm precoated chipping

**Units**

M3

**Quantity**

1,464.94

**Rate build up**

a) *Direct cost (DC)*

i) Unit work Price

1) Material Cost

Description	Units	Quantity	Market Price	Amount
<b><i>Sub Total For Material</i></b>				

2) Labour Price

Personnel	No. Required	Rate /day	Amount
<b><i>Sub Total For Labor</i></b>			
Productivity ratio			

3) Machinery

Machinery type	No. Required	Rate /day	Amount	Hired/Owned
<b><i>Sub Total for Machinery</i></b>				
Productivity ratio				

Sub-total of unit price

Sum (1+2+3)

ii) Haulage Cost

Sub-totals of DC

b) *Indirect Cost*

c) *Overheads and Profits*

**Total Cost**

Sum (a+b+c)

Forwarded to the BOQ

(Bill no: 15-60-004)

**Notes:**

- Attach current (atleast 30 days before tender opening date) proof of cost of materials e.g. Proforma Invoices/quotations.
- The form shall be based on the principles of Cost Estimation Manual. The Cost Estimation Manual can be downloaded from the following website (<https://krb.go.ke/downloads>)

I certify that the above information is correct

.....  
(Title)

.....  
(Signature)

.....  
(Date& Official Stamp)

## Form for Detailed Breakdown of Cost Comparison

**Bill item No.**

15-92-002

**Description**

Provide, heat and spray 80/100 pen grade bitumen for single seal on carriageway, on shoulders, busbays and junction at rate of 0.8-1.2 lts/m<sup>2</sup>

**Units**

litre

**Quantity**

153,120.00

**Rate build up**

a) *Direct cost (DC)*

i) Unit work Price

1) Material Cost

Description	Units	Quantity	Market Price	Amount
<b>Sub Total For Material</b>				

2) Labour Price

Personnel	No. Required	Rate /day	Amount
<b>Sub Total For Labor</b>			
Productivity ratio			

3) Machinery

Machinery type	No. Required	Rate /day	Amount	Hired/Owned
<b>Sub Total for Machinery</b>				
Productivity ratio				

Sub-total of unit price

Sum (1+2+3)

ii) Haulage Cost

Sub-totals of DC

b) *Indirect Cost*

c) *Overheads and Profits*

**Total Cost**

Sum (a+b+c)

Forwarded to the BOQ  
(Bill no: 15-92-002)

**Notes:**

- Attach current (atleast 30 days before tender opening date) proof of cost of materials e.g. Proforma Invoices/quotations.
- The form shall be based on the principles of Cost Estimation Manual. The Cost Estimation Manual can be downloaded from the following website (<https://krb.go.ke/downloads>)

I certify that the above information is correct

.....  
(Title)

.....  
(Signature)

.....  
(Date& Official Stamp)

## Form for Detailed Breakdown of Cost Comparison

**Bill item No.**

16-80-001

**Description**

Provide, lay and roll Asphalt concrete (AC) Type 1 (bitumen content 5-6% by weight) as directed by the Engineer

**Units**

M<sup>3</sup>

**Quantity**

1,129.28

**Rate build up**

a) Direct cost (DC)

i) Unit work Price

1) Material Cost

Description	Units	Quantity	Market Price	Amount
<b>Sub Total For Material</b>				

2) Labour Price

Personnel	No. Required	Rate /day	Amount
<b>Sub Total For Labor</b>			
Productivity ratio			

3) Machinery

Machinery type	No. Required	Rate /day	Amount	Hired/Owned
<b>Sub Total for Machinery</b>				
Productivity ratio				

Sub-total of unit price

Sum (1+2+3)

ii) Haulage Cost

Sub-totals of DC

b) Indirect Cost

c) Overheads and Profits

**Total Cost**

Sum (a+b+c)

Forwarded to the BOQ  
(Bill no. 16-80-001)

**Notes:**

- Attach current (atleast 30 days before tender opening date) proof of cost of materials e.g. Proforma Invoices/quotations.
- The form shall be based on the principles of Cost Estimation Manual. The Cost Estimation Manual can be downloaded from the following website (<https://krb.go.ke/downloads>)

I certify that the above information is correct

.....  
(Title)

.....  
(Signature)

.....  
(Date& Official Stamp)

## Form for Detailed Breakdown of Cost Comparison

**Bill item No.**

16-80-003

**Description**

Provide and spray K-160 as tack coat at a rate of 0.8-1.0 L/sq metre as directed by the Engineer

**Units**

Litre

**Quantity**

37,276.00

s

**Rate build up**

a) *Direct cost (DC)*

i) Unit work Price

1) Material Cost

Description	Units	Quantity	Market Price	Amount
<b>Sub Total For Material</b>				

2) Labour Price

Personnel	No. Required	Rate /day	Amount
<b>Sub Total For Labor</b>			
Productivity ratio			

3) Machinery

Machinery type	No. Required	Rate /day	Amount	Hired/Owned
<b>Sub Total for Machinery</b>				
Productivity ratio				

Sub-total of unit price

Sum (1+2+3)

ii) Haulage Cost

Sub-totals of DC

b) *Indirect Cost*

c) *Overheads and Profits*

**Total Cost**

Sum (a+b+c)

Forwarded to the BOQ  
(Bill no. 16-80-003)

**Notes:**

- Attach current (atleast 30 days before tender opening date) proof of cost of materials e.g. Proforma Invoices/quotations.
- The form shall be based on the principles of Cost Estimation Manual. The Cost Estimation Manual can be downloaded from the following website (<https://krb.go.ke/downloads>)

I certify that the above information is correct

.....  
(Title)

.....  
(Signature)

.....  
(Date& Official Stamp)

**SCHEDULE H:****BASIC PRICES FOR MATERIALS AND LABOUR**

<b>Index Code*</b>	<b>Index Description*</b>	<b>Source of Index*</b>	<b>Base Value and Date*</b>	<b>Bidder's Proposed Weighting</b>	<b>Weighting range</b>
Fixed	Nonadjustable	KNBS CIVIL ENGINEERING COST INDICES DEC 2019	28 DAYS BEFORE THE DATE OF BID OPENING		A= 0.20
LL	Labour				B= 0.08 - 0.12
FU	Fuel and Lubricants				C=0.15 – 0.30
CE	Cement				D=0.08 - 0.12
BI	Bitumen				E=0.08 - 0.3
RS	Reinforcement steel				G=0.02 - 0.2
<b>Total</b>				<b>1.00</b>	

I certify that the above information is correct.

.....  
(Title)

.....  
(Signature)

.....  
(Date)

**FORM OF TENDER SECURITY - DEMAND GUARANTEE**

Beneficiary: \_\_\_\_\_

Invitation to Tender No: \_\_\_\_\_

Date: \_\_\_\_\_

TENDER GUARANTEE No.: \_\_\_\_\_

Guarantor: \_\_\_\_\_

We have been informed that \_\_\_\_\_ (herein after called "the Applicant") has submitted or will submit to the Beneficiary its Tender (hereinafter called "the Tender") for the execution of under Invitation to Tender No. \_\_\_\_ ("the ITT").

Furthermore, we understand that, according to the Beneficiary's conditions, Tenders must be supported by a Tender guarantee.

At the request of the Applicant, we, as Guarantor, hereby irrevocably undertake to pay the Beneficiary any sum or sums not exceeding in total an amount of \_\_\_\_\_ (\_\_\_\_\_) upon receipt by us of the Beneficiary's complying demand, supported by the Beneficiary's statement, whether in the demand itself or a separate signed document accompanying or identifying the demand, stating that either the Applicant:

- a) Has withdrawn its Tender during the period of Tender validity set forth in the Applicant's Form of Tender ("the Tender Validity Period"), or any extension there to be provided by the Applicant; or
- b) Having been notified of the acceptance of its Tender by the Beneficiary during the Tender Validity Period or any extension there to be provided by the Applicant, (i) has failed to execute the contract agreement, or (ii) has failed to furnish the Performance Security, in accordance with the Instructions to Tenderers ("ITT") of the Beneficiary's Tendering document.

This guarantee will expire:

- a) if the Applicant is the successful Tenderer, upon our receipt of copies of the contract agreement signed by the Applicant and the performance Security and, issued to the Beneficiary in relation to such contract agreement; or
- b) if the Applicant is not the successful Tenderer, upon the earlier of (i) our receipt of a copy of the Beneficiary's notification to the Applicant of the results of the Tendering process; or (ii) twenty-eight days after the end of the Tender Validity Period.

Consequently, any demand for payment under this guarantee must be received by us at the office indicated above on or before that date.

\_\_\_\_\_  
[signature(s)]

---

## **PART 2 - WORKS' REQUIREMENTS**

---

## **SECTION VI - BILLS OF QUANTITIES**

### **PREAMBLE TO BILL OF QUANTITIES**

1. The Bills of Quantities shall be read in conjunction with the Instructions to Tenderers, General and Particular Conditions of Contract, Technical Specifications, and Drawings.
2. The quantities given in the Bills of Quantities are estimated and provisional, and are given to provide a common basis for tendering. The basis of payment will be the actual quantities of work ordered and carried out, as measured by the Contractor and verified by the Engineer and valued at the rates and prices tender in the priced Bills of Quantities, where applicable, and otherwise at such rates and prices as the Engineer may fix within the terms of the Contract.
3. The rates and prices tender in the priced Bills of Quantities shall, except in so far as it is otherwise provided under the Contract, include all Constructional Plant, labor, supervision, materials, erection, maintenance, insurance, profit, taxes, and duties, together with all general risks, liabilities, and obligations set out or implied in the Contract.
4. A rate or price shall be entered against each item in the priced Bills of Quantities, whether quantities are stated or not. The cost of Items against which the Contractor has failed to enter a rate or price shall be deemed to be covered by other rates and prices entered in the Bills of Quantities.
5. The whole cost of complying with the provisions of the Contract shall be included in the Items provided in the priced Bills of Quantities, and where no Items are provided, the cost shall be deemed to be distributed among the rates and prices entered for the related Items of Work.
6. General directions and descriptions of work and materials are not necessarily repeated nor summarized in the Bills of Quantities. References to the relevant sections of the Contract documentation shall be made before entering prices against each item in the priced Bills of Quantities.
7. Provisional Sums included and so designated in the Bills of Quantities shall be expended in whole or in part at the direction and discretion of the Engineer in accordance with Sub-Clause 13.5 and Clause 13.6 of the General Conditions.
8. The method of measurement of completed work for payment shall be in accordance with general and special specifications.

The price and rates entered in the Bills of Quantities shall, except insofar as it is otherwise provided under the Contract, include all Constructional plant to be used, labour, insurance, supervision, compliance testing, materials, erection, maintenance of works, overheads and profits, taxes and duties together with all general risks, liabilities and obligations set out or implied in the Contract, transport, electricity and telephones, water, use and replenishment of all consumables, including those required under the contract by the Engineer and his staff.

<b>Bill of Quantities</b>		
	<b>Summary</b>	
<b>Item No.</b>	<b>Description</b>	<b>Billed Amount (Ksh)</b>
1	General: Office administration and overheads/Preliminaries	
4	SITE CLEARANCE AND TOP SOIL STRIPPING	
5	EARTHWORKS	
7	EXCAVATION AND FILLING FOR STRUCTURES	
8	CULVERT AND DRAINAGE WORKS	
9	PASSAGE OF TRAFFIC	
11	PAVED ROAD - SHOULDER MAINTENANCE AND REPAIRS	
12	NATURAL MATERIAL BASES AND SUBBASE	
14	CEMENT AND LIME TREATED SUBGRADE, SUBBASE AND BASE	
15	BITUMINOUS TREATMENTS AND SURFACE DRESSING	
16	BITUMINOUS MIXES	
20	ROAD FURNITURE REPAIR AND MAINTENANCE	
21	MISCELLENEOUS BRIDGE WORKS	
	<b>Sub Total I</b>	
	Add 2.5% (of Sub Total 1) CONTINGENCIES	
	<b>Sub Total II</b>	
	VAT @ 16 %	
	<b>Grand Total</b>	

Bill No. 1	General: Office administration and overheads/Preliminaries				
Item No.	Description	Units	Billed Quantity	Unit Bid Rate(Ksh)	Billed Amount (KSh)
01-80-010A	Payment for material testing as per Clause.. Of Special Specification and as per schedule detailed in Appendix C	L.Sum	300,100.00	1.00	300,100.00
01-80-011A	Extra over 01-80-010A for Contractor's profits and overheads	%	300,100.00		
01-80-016	Provide and erect publicity sign as directed by the Engineer	no	2.00		
01-80-017	Provide, fuel and maintain with drivers 2No. New 4WD double cabin for exclusive use by the Engineer inclusive of the first 4,000km per vehicle month in accordance with clause 138 of Special Specification	V/months	48.00		
01-80-018	Extra over 01-80-017 for mileage over 4,000km	km	5,000.00		
01-80-026A	Payment of Resident Engineer Miscellaneous account as per Clause.. Of Special Specification and for items and services detailed in Appendix B	L.Sum		1.00	
01-80-030A	Payment of Engineers Supervisory Staff including overtime in accordance with clause 137 of Special Specifications and as per Renumeration Rates in Appendix A	L.Sum	11,705,400.00	1.00	11,705,400.00
01-80-031A	Extra over 01-80-030A for Contractor's profits and overheads	%	11,705,400.00		
01-80-090	Allow a Prime Cost Sum of Ksh. 500,000.00 for Environmental Impact Assessment Study and License	PC Sum	500,000.00	1.00	500,000.00
01-80-091	Extra over 01-80-090 for contractors profits and overheads	%	500,000.00		
	<b>Total Carried Forward to Summary:</b>				

**Bill of Quantities**

Page: 3

**Bill No. 4****SITE CLEARANCE AND TOP SOIL STRIPPING**

<b>Item No.</b>	<b>Description</b>	<b>Units</b>	<b>Billed Quantity</b>	<b>Unit Bid Rate (Ksh)</b>	<b>Billed Amount (KSh)</b>
04-60-001	Clear site on road reserve including removal of trees, hedges, bushes and other vegetation or deteriorious organic material, grub up roots and back fill to 100% MDD (AASHTO T99) with approved material in accordance with the specification	m <sup>2</sup>	412,500.00		
	<b>Total Carried Forward to Summary:</b>				

<b>Bill of Quantities</b>					Page: 4
<b>Bill No. 5</b>	<b>EARTHWORKS</b>				
<b>Item No.</b>	<b>Description</b>	<b>Units</b>	<b>Billed Quantity</b>	<b>Unit Bid Rate(Ksh)</b>	<b>Billed Amount (KSh)</b>
05-50-006	Fill in Soft Material and Compact	m <sup>3</sup>	21,120.00		
05-50-008	Cut to Spoil in Soft Material	m <sup>3</sup>	1,760.00		
	<b>Total Carried Forward to Summary:</b>				

**Bill of Quantities**

Page: 5

<b>Bill No. 7</b>	<b>EXCAVATION AND FILLING FOR STRUCTURES</b>					
<b>Item No.</b>	<b>Description</b>	<b>Units</b>	<b>Billed Quantity</b>	<b>Unit Bid Rate(Ksh)</b>	<b>Billed Amount (KSh)</b>	
07-60-001	Excavate and back fill for gabions in soft materials	m <sup>3</sup>	264.00			
07-60-002	Provide and place gabion boxes and mattresses as specified or as directed by the Engineer	m <sup>2</sup>	1,320.00			
07-60-003	Provide and place rock fill to gabions and mattresses	m <sup>3</sup>	240.00			
07-60-004	Allow for grouting of the rock fill where necessary	m <sup>2</sup>	480.00			
07-60-005	Provide and place 200mm thick stone pitching including grouting to aprons upstream and down stream of bridges and culverts as detailed in the drawing or as directed by the Engineer	m <sup>2</sup>	4,000.00			
	<b>Total Carried Forward to Summary:</b>					

**Bill of Quantities**

<b>Bill No. 8</b>		<b>CULVERT AND DRAINAGE WORKS</b>			
<b>Item No.</b>	<b>Description</b>	<b>Units</b>	<b>Billed Quantity</b>	<b>Unit Bid Rate(Ksh)</b>	<b>Billed Amount (KSh)</b>
08-60-008	Culvert Cleaning- Fully Blocked - 600mm	m	360.00		
08-60-009	Culvert Cleaning- Fully Blocked - 900mm	m	120.00		
08-60-025	Culvert Installation 600 mm with surround	m	390.00		
08-60-027	Culvert Installation 900 mm with surround	m	120.00		
08-90-001	Excavate for inlet, out fall, catch water drains, mitre and cut-off drains in soft material	m <sup>3</sup>	6,750.00		
08-90-003	Excavation in soft material for pipe culverts, headwalls, wingwalls, apron, toe walls and drop inlets and compact as specified or as directed by the Engineer	m <sup>3</sup>	563.75		
08-90-008	Provide and place class 15/20 concrete to beds	m <sup>3</sup>	231.96		
08-90-009	Provide and place class 25/20 concrete to headwalls, wing walls, aprons, sorrounds to walls, inlets and outlets to pipe culverts including formwork	m <sup>3</sup>	410.73		
08-90-005	Excavate , remove and dispose of exisiting damaged pipe culverts as directed by the Engineer	m	120.00		
<b>Total Carried Forward to Summary:</b>					

**Bill of Quantities**

Page: 7

<b>Bill No. 9</b>	<b>PASSAGE OF TRAFFIC</b>				
<b>Item No.</b>	<b>Description</b>	<b>Units</b>	<b>Billed Quantity</b>	<b>Unit Bid Rate(Ksh)</b>	<b>Billed Amount (KSh)</b>
09-60-001	Allow for the passage of traffic through the works	LS Sum		1	

**Bill of Quantities**

Page: 8

**Bill No. 11****PAVED ROAD - SHOULDER MAINTENANCE AND REPAIRS**

<b>Item No.</b>	<b>Description</b>	<b>Units</b>	<b>Billed Quantity</b>	<b>Unit Bid Rate(Ksh)</b>	<b>Billed Amount (KSh)</b>
11-50-002	Prepare surface of existing shoulders, accesses and busbays, including benching where necessary, water, process and compact in accordance with the specifications and as directed by the Engineer to receive gravel	m <sup>2</sup>	127,600.00		
11-50-003	Provide, place and compact natural gravel to shoulders, accesses and busbays	m <sup>3</sup>	19,140.00		
	<b>Total Carried Forward to Summary:</b>				

**Bill of Quantities**

Page: 9

<b>Item No.</b>	<b>Description</b>	<b>Units</b>	<b>Billed Quantity</b>	<b>Unit Bid Rate(Ksh)</b>	<b>Billed Amount (KSh)</b>
12-50-002	Provide, place, spread and compact natural gravel for subbase	m <sup>3</sup>	907.50		
12-50-003	Provide, place, spread and compact natural gravel for base	m <sup>3</sup>	907.50		
12-50-007	Scarify the existing pavement layers (including surfacing) and add additional subbase gravel (measured separately) to form the subbase layer	m <sup>3</sup>	178.75		
	<b>Total Carried Forward to Summary:</b>				

<b>Bill of Quantities</b>					Page: 10
<b>Bill No. 14</b>	<b>CEMENT AND LIME TREATED SUBGRADE, SUBBASE AND BASE</b>				
<b>Item No.</b>	<b>Description</b>	<b>Units</b>	<b>Billed Quantity</b>	<b>Unit Bid Rate(Ksh)</b>	<b>Billed Amount (KSh)</b>
14-50-001	Provide, transport, spread, cement stabilizer on material	ton	962.28		
14-50-003	Mixing in cement/lime stabilizer into natural gravel	m <sup>3</sup>	20,955.00		
14-50-004	Curing and protection of treated layers	m <sup>2</sup>	139,700.00		
	<b>Total Carried Forward to Summary:</b>				

<b>Bill No.</b> 15	<b>BITUMINOUS TREATMENTS AND SURFACE DRESSING</b>				
<b>Item No.</b>	<b>Description</b>	<b>Units</b>	<b>Billed Quantity</b>	<b>Unit Bid Rate(Ksh)</b>	<b>Billed Amount (KSh)</b>
15-50-001	Prepare surface to receive treatment.	m <sup>2</sup>	133,650.00		
15-50-002	Provide and spray MC 30 cut-back bitumen as prime coat to carriageway, shoulders, busbays and junctions at rate 0.8-1.2lts/m2 as prime coat	l	160,380.00		
15-60-004	Provide, spread and roll 10/40 mm precoated chipping	m <sup>3</sup>	1,464.94		
15-92-002	Provide, heat and spray 80/100 pen grade bitumen for single seal on carriageway, on shoulders, busbays and junction at rate of 0.8-1.2 lts/m2	l	153,120.00		
	<b>Total Carried Forward to Summary:</b>				

**Bill of Quantities**

<b>Bill No. 16</b>		<b>BITUMINOUS MIXES</b>			
<b>Item No.</b>	<b>Description</b>	<b>Units</b>	<b>Billed Quantity</b>	<b>Unit Bid Rate(Ksh)</b>	<b>Billed Amount (KSh)</b>
16-50-004	Repair transverse or longitudinal cracking on surface dressed or asphalt concrete	m	3,000.00		
16-50-004A	Asphalt reinforcement grid-Geotextile	m <sup>2</sup>	1,950.00		
16-80-001	Provide, lay and roll asphalt concrete type 1 (bitumen content 5-6% by weight) as directed by the Engineer	m <sup>3</sup>	1,129.28		
16-80-003	Provide and spray K-160 as tack coat at a rate of 0.8-1.0 L/sq metre as directed by the Engineer	l	37,276.00		
16-80-004	Clearing and cutting of potholes and failed areas	m <sup>2</sup>	3,000.00		
16-50-002	Pothole Patching - cold mix	m <sup>3</sup>	20.00		
	<b>Total Carried Forward to Summary:</b>				

**Bill of Quantities**

<b>Bill No. 20</b>		<b>ROAD FURNITURE REPAIR AND MAINTENANCE</b>			
<b>Item No.</b>	<b>Description</b>	<b>Units</b>	<b>Billed Quantity</b>	<b>Unit Bid Rate(Ksh)</b>	<b>Billed Amount (KSh)</b>
20-50-010	Guardrail installation	m	600.00		
20-70-002	Provide and erect warning type signs 750mm size	no	26.00		
20-70-004	Provide and erect standard informatory signs 400*300 mm	no	14.00		
20-70-005	Provide and erect mandatory signs 600mm diameter	no	24.00		
20-70-008	Provide and erect Non-Standard informatory signs: (c) 2-5m2 area	no	2.00		
20-70-009	Provide and erect Non-Standard informatory signs: (d) >5m2 area	no	6.00		
20-70-027	Provide, plant, water and tender trees seedlings until firmly established as directed by the Engineer	NO.	4,000.00		
20-70-010	Paint 0.1m with thermoplastic yellow centreline on the road as specified	m2	2,900.00		
20-70-011	Paint 0.1m with thermoplastic white centreline on the road as specified	m2	5,800.00		
20-50-006	Road marking - Yellow paint	m <sup>2</sup>	200.00		
20-50-007	Road marking - White paint	m <sup>2</sup>	400.00		
20-70-025	Provide white reflective delineators (cat eyes) as directed by the Engineer	no	600.00		
<b>Total Carried Forward to Summary:</b>					

**Bill of Quantities**

Page: 14

<b>Bill No. 21</b>	<b>MISCELLANEOUS BRIDGE WORKS</b>				
<b>Item No.</b>	<b>Description</b>	<b>Units</b>	<b>Billed Quantity</b>	<b>Unit Bid Rate(Ksh)</b>	<b>Billed Amount (KSh)</b>
21-70-007	Provide and fix handrails at the sides of the bridge deck including providing and erecting vertical angle iron posts,bolts, nuts and welding including any treatment for all steel before and after construction.	m	40.00		
21-70-008	Provide and construct galvanised Armco flex beam guardrails or equal approved at the sides of the bridge deck	m	40.00		
	<b>Total Carried Forward to Summary:</b>				

<b>PART I</b>							
<b>RATES FOR EENGINEERS SUPERVISORY STAFF</b>							
<b>NO.</b>	<b>DESIGNATION</b>	<b>KeNHA Grade</b>	<b>Rates</b>				
			<b>Wages &amp; Salaries (Monthly)</b>	<b>Per Diem - Cluster 1 (Daily)</b>	<b>Per Diem - Cluster 2 (Daily)</b>	<b>Per Diem - Cluster 3 (Daily)</b>	<b>Field Allowance (Daily)</b>
<b><u>1. Engineers</u></b>							
1	Director General			18,200.00	12,600.00	10,500	-
2	Director			16,800.00	12,600.00	10,500	-
3	Resident Engineer (DD)/Deputy Director	3		16,800.00	12,600.00	10,500	-
4	Resident Engineer (AD)	4		14,000.00	10,500.00	8,400	-
5	Senior Engineer	5		14,000.00	10,500.00	8,400	-
6	Engineer	6		11,200.00	8,400.00	7,000	-
7	Senior Engineer (Projects)			6,300.00	4,900.00	4,200	-
8	Engineer (Projects)			6,300.00	4,900.00	4,200	-
9	Assistant Engineer (Projects)			6,300.00	4,900.00	4,200	-
10	Intern Engineer (Projects)			6,300.00	4,900.00	4,200	-
<b><u>2. Inspectorate</u></b>							
1	Roads Superintendent	7		11,200.00	8,400.00	7,000	1,750.00
2	Roads Inspector	8		11,200.00	8,400.00	7,000	1,750.00

3	Roads Overseer	9		6,300.00	4,900.00	4,200	1,050.00
4	Inspector (Projects)			6,300.00	4,900.00	4,200	-
5	Assistant Inspector (Projects)			6,300.00	4,900.00	4,200	-
<b><u>3. Laboratory</u></b>							
1	Material Technologist			11,200.00	8,400.00	7,000	1,750.00
2	Lab Technician			6,300.00	4,900.00	4,200	1,050.00
3	Lab Attendant			6,300.00	4,900.00	4,200	1,050.00
4	Lab Technician (Projects)			6,300.00	4,900.00	4,200	1,050.00
5	Lab Attendant (Projects)			6,300.00	4,900.00	4,200	1,050.00
<b><u>4. Survey</u></b>							
1	Senior Surveyor	5		14,000.00	10,500.00	8,400	2,100.00
2	Surveyor	6		11,200.00	8,400.00	7,000	1,750.00
3	Senior Assistant Surveyor	7		11,200.00	8,400.00	7,000	1,750.00
4	Surveyor (Projects)			6,300.00	4,900.00	4,200	-
5	Assistant Surveyor (Projects)			6,300.00	4,900.00	4,200	-
6	CAD Technician (Projects)			6,300.00	4,900.00	4,200	-
7	Leveller (Projects)			6,300.00	4,900.00	4,200	-
8	Chainman (Projects)			6,300.00	4,900.00	4,200	-
<b><u>5. Drivers</u></b>							

1	Senior Driver	8		11,200.00	8,400.00	7,000	1,750.00
2	Driver	9		6,300.00	4,900.00	4,200	1,050.00
3	Driver (Projects)			6,300.00	4,900.00	4,200	-
<b>6. Admin</b>							
1	Senior Officer	5		14,000.00	10,500.00	8,400	-
2	Officer	6		11,200.00	8,400.00	7,000	-
3	Senior Assistant Officer	7		11,200.00	8,400.00	7,000	-
4	Assistant Officer	8		11,200.00	8,400.00	7,000	-
5	Senior Office Assistant	9		6,300.00	4,900.00	4,200	-
6	Office Assistant	10		6,300.00	4,900.00	4,200	-
7	Accountant (Projects)			6,300.00	4,900.00	4,200	-
8	Assistant Accountant (Projects)			6,300.00	4,900.00	4,200	-
9	Procurement Officer (Projects)			6,300.00	4,900.00	4,200	-
10	Assistant Procurement Officer (Projects)			6,300.00	4,900.00	4,200	-
11	Environmental Officer (Projects)			6,300.00	4,900.00	4,200	-
12	Assistant Environmental Officer (Projects)			6,300.00	4,900.00	4,200	-
13	ICT Officer (Projects)			6,300.00	4,900.00	4,200	-
14	Assistant ICT Officer (Projects)			6,300.00	4,900.00	4,200	-

15	Human Resource Officer (Projects)			6,300.00	4,900.00	4,200	-
16	Asst. Human Resource Officer (Projects)			6,300.00	4,900.00	4,200	-
17	Secretary (Projects)			6,300.00	4,900.00	4,200	-
18	Office Assistant (Projects)			6,300.00	4,900.00	4,200	-
19	Office Attendant (Projects)			6,300.00	4,900.00	4,200	-
20	Casual Laborer (Daily)			1,000.00	1,000.00	1,000	-
21	Intern			6,300.00	4,900.00	4,200	-
22	Attachee			6,300.00	4,900.00	4,200	-
<b><u>7. Security (Police Officers)</u></b>							
1	Inspector	8		11,200.00	8,400.00	7,000.00	
2	Senior Sergeant	8		11,200.00	8,400.00	7,000.00	
3	Sergeant	8		11,200.00	8,400.00	7,000.00	
4	Corporal	9		6,300.00	4,900.00	4,200.00	
5	Constable	10		6,300.00	4,900.00	4,200.00	
<b>SUB TOTAL A (Allowances Provision KeNHA Staff for the Contract Duration)</b>							<b>1,222,200.00</b>
<b>PART II</b>							
<b>KeNHA PROJECT STAFF RENUMERATION SCALE</b>							
<b>1. TECHNICAL STAFF</b>							
<b>Civil Engineering Degree Holders</b>							

S/n	Staff Designation	Minimum Qualifications	Gross Monthly Renumeration (Man Months) (KShs)
1	Senior Engineer	i. Holds a Degree in Civil Engineering or its equivalent. ii. Registered <b>Professional</b> Civil Engineer with EBK and a <b>corporate</b> member of IEK. iii. Has Worked with KeNHA for over 3 years.	206,400.00
2	Engineer	i. Holds a Degree in Civil Engineering or its equivalent from an institution recognized by EBK. ii. Registered <b>Graduate</b> Civil Engineer with EBK. iii. Has over <b>5 years Post-Registration</b> Experience in Roads. iv. Has Worked with KeNHA for over 3 years.	117,500.00
3	Assistant Engineer	i. Holds a Degree in Civil Engineering or its equivalent from an institution recognized by EBK. ii. Registered <b>Graduate</b> Civil Engineer with EBK. iii. Has over <b>3 years Post-Registration</b> Experience in Roads. iv. Has Worked with KeNHA for over 2 years.	93,500.00
4	Graduate Engineer	i. Holds a Degree in Civil Engineering or its equivalent from an institution recognized by EBK. ii. Registered <b>Graduate</b> Civil Engineer with EBK. iii. Has over <b>1 year Post-Registration</b> Experience.	71,500.00
5	Trainee Engineer/ Intern	i. Holds a Degree in Civil Engineering or its equivalent from an institution recognized by EBK. ii. Registered or awaiting Registration as a <b>Graduate</b> Civil Engineer with EBK. ii. <b>Fresh Graduate</b> from University.	25,000.00

#### Civil Engineering Diploma Holders

S/n	Staff Designation	Minimum Qualifications	Gross Monthly Renumeration (Man Months) (KShs)
1	Superintendent	i. Holds a Diploma in Civil Engineering - Highways Category. ii. Has over <b>6 Years Post graduation</b> Practical Experience in Roads. iii. Has worked with KeNHA for over 4 years.	93,500.00
2	Inspector	i. Holds a Diploma in Civil Engineering - Highways Category. ii. Has over <b>3 Years Post graduation</b> Practical Experience in Roads. iii. Has worked with KeNHA for over 2 years.	71,500.00
3	Assistant Site Inspector	i. Holds a Diploma in Civil Engineering - Highways Category. ii. Has over <b>2 Years Post Graduation</b> Practical Experience in Roads.	52,500.00
4	Trainee Site Inspector	i. Holds a Diploma in Civil Engineering - Highways Category.	30,000.00

		ii. Fresh Graduate.	
<b>Construction/Project Management Degree Holders</b>			
S/n	Staff Designation	Minimum Qualifications	Gross Monthly Renumeration (Man Months) (KShs)
1	Project Inspector	i. Holds a Degree in Project or Construction management or its equivalent.	71,500.00
		ii. Construction Managers must be registered as Professionals with ACMK (Assosiation of Construction Managers of Kenya) while Project Managers must be registered with KAPM (Kenya Assosiation of Project Managers) and PMI (Project Management Institute) as professionals.	
		iii. Has over 5 Years Post Graduation Experience	
2	Assistant Project Inspectors	i. Holds a Degree in Project or Construction management or its equivalent.	52,500.00
		ii. Construction Managers must be registered as Graduate members with ACMK (Assosiation of Construction Managers of Kenya) while Project Managers must be registered with KAPM (Kenya Assosiation of Project Managers)	
		iii. Has over 3 years post Graduation Practical Experience	
3	Trainee Project Inspector	i. Holds a Degree in Project or Construction management or its equivalent.	30,000.00
		ii. <b>Fresh Graduate</b>	
<b>Surveyors</b>			
S/n	Staff Designation	Minimum Qualifications	Gross Monthly Renumeration (Man Months) (KShs)
1	Senior Surveyor	i. Holds a Degree in Survey or its equivalent	204,600.00
		ii. Registered as a Professional Member with the Institute of Surveyors of Kenya	
		iii. Has over 5 Years of Practical Experience in Roads.	
2	Surveyor	i. Holds a Degree in Survey or its equivalent	117,500.00
		ii. Registered as a Graduate Member with the Institute of Survey of Kenya	
		iii. Has over 3 Years of Practical Experience in Roads.	
3	Assistant Surveyor/Leveller	i. Holds a Degree/Diploma in Survey or its equivalent	71,500.00
		ii. Fresh from college	
4	Chainman	i. Has over 1 year of practical experience in roads survey	36,500.00
<b>2. NON-TECHNICAL STAFF</b>			
Finance Office			

1	Assistant Accountant	Holds a Bachelors of Commerce (Finance & Banking) or it's equivalent.	71,500.00
		Holds atleast CPA-I	
		Has atleast 3 years post graduate practical experience.	
		Has worked with KeNHA for over 2 years.	
2	Trainee Accountant	Holds a Bachelors of Commerce (Finance & Banking) or it's equivalent.	52,500.00
		Fresh from university	
<b>Procurement Office</b>			
1	Procurement Officer	Holds a Degree in Supply Chain Management or its equivalent	117,500.00
		Has over 3 years of experience.	
		Has worked with KeNHA for over 2 Year	
2	Assistant Procurement Officer	Holds a Diploma in Supply Chain Management or its equivalent	71,500.00
		Has worked with KeNHA for over 1 Year	
3	Trainee Procurement Officer	Holds a Degree/Diploma in Supply Chain Management or its equivalent	52,500.00
		Fresh From college	
<b>Procurement Office</b>			
1	Information Communications Technology Officer	Holds a Degree in Information Technology, Computer Science/Engineering or any other relevant and equivalent qualification from a recognized Institution.	117,500.00
		Has over 3 years of experience.	
		Has worked with KeNHA for over 2 Year	
2	Assistant Information Communications Technology Officer	Holds a Diploma in Computer Science, Information Technology or other relevant and equivalent qualifications from a recognized Institution	52,500.00
		Has worked with KeNHA for over 1 Year	
<b>Administration</b>			
1	Assistant Human Resource	Holds a Bachelors Degree in Business Administration (Human Resource Management) or its equivalent.	71,500.00
		Has worked with KeNHA for over 2 years.	
<b>Office Assistant</b>			
1	Office Assistant/Clerks	Has O-Level Certificate or its equivalent.	36,500.00
		Trained on data keeping and/or computer applications.	
<b>SUB TOTAL B</b>			12,031,200.00
<b>Provision of a lumpsum to be expended in overtime and allowances in accordance to Labour Laws and Human Resource procedures &amp; guidelines (30% of Sub Total B)</b>			
<b>SUB TOTAL C (SUBTOTAL B + Provisional Sum for Overtime and Allowances)</b>			15,640,560.00
<b>GRAND TOTAL CARRIED FORWARD TO BILL 01-80-030A (SUB TOTAL A + SUB TOTAL C)</b>			16,950,960.00

## APPENDIX B

### KeNHA RE's OFFICE MISCELLANEOUS EXPENSES

<b>1. Stationaries &amp; Consumables</b>					
NO.	DESCRIPTION	UNIT	Quantity	Rate(Ksh)	Amount (Ksh)
1	A3 Photocopy Papers (White)	Reams	2		
2	A4 Photocopy Papers (White)	Reams	40		

3	A4 Photocopy Papers (Coloured)	Reams	20		
4	Paper Conqueror Laid A4 (Blue,Cream)	Reams	20		
5	Hp Laser Jet Pro M102a CF 219A	No.	2		
6	Hp Laser Jet P1102 CE 285A	No.	2		
7	External Hard Disk 1TB	No.	2		
8	In/OutTray	No.	8		
9	Flash Disks 8GB	No	4		
10	Flash Disks 16GB	No.	8		
11	Flash Disk 32GB	No	4		
12	Thuraya Satelite Phone	No.	2		
13	Thuraya Satelite Airtime	Units	72		
14	Reflector Jackets (Cloth-Custom made & KeNHA branded)	No	24		
15	Cooler Box	No	2		
16	Measuring Tapes 30fts	No	6		
17	Scientific Calculator	No	6		
18	Uni-ball pens (Blue/Black)	Pkt.	8		
19	Stapler Removers	No.	10		
20	Highlighters	No.	20		
21	Marker Pens	No.	20		
22	Stick Notes	No	40		
23	Short Hand Note Books	No.	40		
24	Muster Rolls Books	No.	2		
25	Biro Pens Sharp Pointed- Black	No.	200		
26	Biro Pens Sharp Pointed Blue	No.	200		
27	Biro Pens Sharp Pointed Red	No.	200		
28	Box File Medium (PVC)	No.	40		
29	Counter Books A4 (4 Quire)	No.	20		
30	Envelopes Brown Size 4.3 X 8.7 Inch	No.	400		
31	Envelopes Brown - A3	No.	400		
32	Envelopes Brown-A4	No.	400		
33	Envelopes Brown-A5	No.	400		
34	Highlighting Pens	No.	60		
35	Paper Punch Medium	No.	10		
36	Pelikan ink 273	No.	20		
37	Short Hand Note Books - A5	No.	100		
38	Staple Pins 24/6	Pkts	100		
39	Transparent Folders	No.	100		
40	Paper Clips 28mm	No.	100		
42	Stamp Pad Ink (Blue & Red)	No.	20		
43	White Out	No.	20		
44	Cello tape 1 inch	No.	20		
45	Embossed Covers (Blue & Green)	Reams	20		
46	Clear Pocket Folder	pcs	100		
47	Glue Stick Pritt	No.	20		
48	Pencils	No.	200		
49	Delivery Book	No.	4		
50	Stick notes (Sign here)	No.	200		

51	Safety Boots	No	24		
<b>2. Staff Welfare</b>		-	-	-	-
1	Kitchen detergents	Lot	2		
2	Dust Coats & Masks	No.	40		
3	Milk	Ltrs	240		
4	Sugar	Kgs	100		
5	Assorted beverages	Pkts	6		
6	Hand Sanitizers (500) ml	No.	10		
7	Hand washing gels (Dettol).250 ml	No.	80		
8	Refillable Drinking water (20LTS) Bottle	No.	72		
9	Drinking water (Small bottles)	Box (12 pcs)	100		
10	<b>SubTotal A</b>				
<b>3. Consumables and Allowances</b>		-	-	-	-
1	Lunches	No	24	20,000.00	480,000.00
<b>SubTotal B</b>					<b>480,000.00</b>
<b>GRAND TOTAL CARRIED FORWARD TO BILL ITEM 01-80-026A</b>					

<b>APPENDIX C</b>					
<b><u>LAB TESTS CHARGE SHEET AS PER MTRD</u></b>					
-	-	-	-	-	-
CONCRETE CUBES					

S/No.	Description	Cost (Kshs)	No of Test	Total Cost (Kshs)
1	Making and Crushing of cubes (set of 3)	1500	3	4,500.00
<b>AGGREGATES</b>				
1	Flakines Index (FI)	600	3	1,800.00
2	Bulk Density	500	3	1,500.00
3	LAA	1000	3	3,000.00
4	ACV	1000	3	3,000.00
5	Seave Analysis(Course Aggregates)	500	3	1,500.00
6	Seave Analysis(Fine Aggregates and Sand)	500	3	1,500.00
7	Water Absorbtion and Specific Gravity	900	3	2,700.00
8	Silt and Clay Content	500	3	1,500.00
9	10% Fines	1200	7	8,400.00
10	Weathering 5 cycles(SSS) on crushed graded aggregares (ASTM)	3000	2	6,000.00
11	Arithmetical Mix Design(Calculation only)	2500	1	2,500.00
12	Concrete mix Design (Complete)	10000	1	10,000.00
13	Sand Equivalent	1000	7	7,000.00
14	Bulking Curves for sand	800	7	5,600.00
<b>TAR,BITUMEN,ASPHALTS &amp; SEALING COMPOUNDS</b>				
1	Desiltation of volatiles	750	3	2,250.00
2	Water Content in Bitumen	750	3	2,250.00
3	Penetration Test	500	3	1,500.00
4	Softening Point	500	3	1,500.00
5	Viscosity of Petroleum Products	750	3	2,250.00
6	Mix Design including Marshall & Voids	15000	2	30,000.00
7	Crushing Marshall Specimen (Sets of 3)	1800	3	5,400.00
8	Solubility in Trychloroethylene or Carbon Di-sulphide	750	3	2,250.00

9	Ductility Test in Bitumen	500	3	1,500.00
10	Differenciation Between Tar and Bitumen (Spot Test Only)	300	3	900.00
11	Flash Point of Petroleum Products	750	3	2,250.00
12	Affinity for Bitumen	750	4	3,000.00
13	Loss on Heating Test	1000	1	1,000.00
14	Mix Design by vibrating Hummer Method	15000	2	30,000.00
15	Spread and Spray Rate Measurement per test	1000	7	7,000.00
16	CutBack Bitumen Design and Analysis	10000	1	10,000.00
SOIL ANALYSIS				
1	Determiation of liquid,plastic and linear shinkage (Atterbergs)	500	7	3,500.00
2	Seave Analysis Down to 200 Mesh (0.075mm) Wet	500	7	3,500.00
3	Complete sieve analysis	1000	7	7,000.00
4	Moisture density (compaction test) BS or MOD, AASHTO T180	1100	7	7,700.00
5	CBR dyamically compacted at 3 levels, 95% MDD MOD AASHTO day soak	1800	7	12,600.00
6	CBR for stabilization and 7 day cure and 7 day soak and statitally compacted to 95%MDD.MOD.AASHTO	2400	7	16,800.00
7	CBR for stabilized samples	1200	7	8,400.00
8	Moisture content determination	400	7	2,800.00
9	Sand replacement test	900	7	6,300.00
10	Sand replacement test for stabilised samples	750	7	5,250.00
11	Moisture/Density content determination (Compaction Test) Proctor T90 - Sample Preparation before testing	300	7	2,100.00
12	Moisture/Density content determination (Compaction Test) Proctor T90 - Vibrating Hammer	1600	7	11,200.00
OTHERS				
1	Chemical Analysis of Cement	4000	1	4,000.00

2	Thermoplastic Paint Testing with beeds	10000	1	10,000.00
3	Cat eyes	4400	1	4,400.00
4	Guardrail Flex Beam, Post,Bolts and Nuts	6500	1	6,500.00
5	Gabion Box	6500	1	6,500.00
6	Major Tests on AC	18000	1	18,000.00
<b>GRAND TOTAL CARRIED FORWARD TO BILL ITEM 01-80-010A</b>				<b>300,100.00</b>

## **SECTION VII - SPECIFICATIONS**

### **102 LOCATION OF CONTRACT**

The Project road is located in Nakuru and Baringo Counties. The Road starts at Kampi ya Moto and proceeds through Mogotio and terminates at Emining along (B17) Road. The road is approximately 29 kms.

### **103 EXTENT OF CONTRACT**

The works to be executed under the Contract comprise mainly but not limited to the following as shall be directed by the Engineer;

- General: Office Administration and Overheads
- Site Clearance
- Earthworks
- Protection works: gabions and stone pitching
- Drainage works: Provision of access and cross culverts (600mm dia and 900mm dia)
- Shoulder Reinstatement of 29km.
- Natural Material Subbase and Base Reconstruction
- Bituminous surface Treatments
- Regulation and Surfacing using Asphalt concrete Type 1
- Passage of Traffic
- Installation road furniture and maintenance
- Miscellaneous Bridge works
- Any other works as may be instructed by the Engineer

Any other activity not listed above in either category but deemed to be necessary by the Engineer, shall be subject to the Engineer's formal instructions within the mode of payment stipulated either by day works or on a measured basis.

### **104 PROGRAMME OF EXECUTION OF THE WORKS**

The contractor shall provide the works programme, required under clause 14 of the Conditions of Contract, within 14 days of receipt of the Engineer's Order to commence work.

The programme shall be co-ordinated with climatic and other conditions to provide for the completion of the works in the order and by the time specified.

The Contractor shall carry out the contract in accordance with the programme agreed with the Engineer, but he shall in no manner be relieved by the Engineer's approval of the programme, of his obligation to complete the works in the prescribed order and by the prescribed completion date and he shall from time to time review his progress and make such amendments to his rate of execution of the works as may be necessary to fulfil his obligations.

### **105 ORDER OF EXECUTION OF WORKS**

In addition to Clause 105 of the Standard Specification the Contractor shall carry out the Works such that a continuous and consecutive output of fully completed work is achieved.

## **107 TAKING OVER CERTIFICATE**

The minimum length of the road for which a certificate will be issued under clause 48 of the conditions of Contract shall be a whole length of the road substantially completed.

## **109 NOTICE OF OPERATIONS**

Add the following sub- Clause.

### Notification Terms

It shall be the Contractor's responsibility to notify the Engineer when any item of works scheduled are completed and ready for approval, and the contractor shall give sufficient notice to allow control test to be performed.

### Explosive and Blasting

The requirements of the Laws of Kenya governing explosives and other requirements and regulations of Government of Kenya and other authorities shall be complied with.

No explosives of any kind shall be used without prior written consent of the Engineer.

The Contractor shall be solely responsible for the provision, handling, storage and transporting of all explosives, ancillary materials and all other items of related kind whatsoever required for blasting.

## **120 PROTECTION OF EXISTING WORKS AND SERVICES**

The Contractor shall acquaint himself with the position of all existing services such as sewers, water drains, cables for electricity and telephone, lighting and telephone poles, water mains, etc., before commencing any excavation or other work likely to affect the existing services.

The cost of all plant, equipment and materials, labour, technical and professional staff, transport and the like necessary for determining the locations of existing services, including the making good of any damage caused to such services all to the satisfaction of the Engineer, shall be deemed to be included in the tender rates. No other payment shall be made for the costs of such operations, nor for the making good of damage caused thereby to the existing services.

The Contractor shall be held responsible for injury to existing structures, works or services and shall indemnify and keep indemnified the Employer against any claims in this respect (including consequential damages).

## **124 LAND FOR ALL CAMPS SITES AND FOR THE CONTRACTOR'S OWN PURPOSES, INCLUDING TEMPORARY WORKS.**

Notwithstanding Clause 124 of the Standard Specification all requirements of land for temporary works and construction purposes shall be to the approval of the Engineer but the Contractor will make all necessary arrangements with the property owners concerned and pay all charges arising therefrom. On or before completion of the Contract, the Contractor shall remove all temporary works and shall restore all such land to the condition in which it was immediately prior to the occupation thereof as far as is reasonable and practicable. No separate payment will be made to the Contractor on account of these items and the Contractor must make due allowance for them in his rates.

Notwithstanding Clause 120 of the Standard Specifications, the Contractor shall be required to appoint competent surveyors who will liaise with the Engineer on matters related to the demarcation of the existing road reserve, site measurements, removal and reinstatement of existing services.

## 128 STORAGE OF MATERIALS

All materials shall be stored on Site in a manner approved by the Engineer and the Contractor shall carefully protect from the weather all work and materials which may be affected thereby.

## 129 TEST CERTIFICATES

When instructed by the Engineer the Contractor shall submit certificates of test from the suppliers of materials and goods required in connection with the works as the Engineer may require.

Such certificates shall certify that the materials or goods concerned have been tested in accordance with the requirements of the specifications and shall give the results of all the tests carried out. The Contractor shall provide adequate means of identifying the materials and goods delivered to the site with the corresponding certificates.

## 131 SIGNBOARDS

The Contractor shall provide and erect two (2) publicity signs on the site as directed. The Engineer shall, as shown in the Drawings, direct the minimum dimensions and thickness of the steel framework and sheet. The framework and sheet shall be prepared and painted black, while the ring at the top of the supporting frames shall be painted white. The wordings and KeNHA's logo shall be printed on backlit sticker paper resistant to the effects of weather using reflectorized paint or material approved by the Engineer. The colours, fonts and heights of the letters shall be as indicated on the attached drawings and as directed by the Engineer.

- (a) After extraction of materials, all borrows pits shall be backfilled to the satisfaction of the Engineer. In particular borrow pits near the project road shall be backfilled in such a way that no water collects in them.
- (b) Spilling of bitumen fuels Oils and other pollutants shall be cleared up.
- (c) Including removal of excavated material from the pavement to spoil.

Signboard shall be removed and transported to RM's Yard at the end of Defects liability Period.

### 131.1 HOUSING ACCOMMODATION FOR THE RESIDENT ENGINEER AND HIS STAFF, OFFICE AND LABORATORY INCLUDING FURNITURE

### 131.2 HOUSING AND ACCOMMODATION FOR THE ENGINEER'S SENIOR STAFF

The contractor shall **provide** or **rent** for the Engineer's site staff. This staff will generally comprise the following;

<b>Designation</b>	<b>Number</b>
Resident Engineer	1
Assistant Resident Engineer	1
Materials Engineer	1
Surveyor	1
Senior Inspector	1

Senior Lab. Technologist	1
Inspectors	4
Lab Technician	3
CAD Technician	1
Chain Men	2
Leveler	1

Payment shall be as per the bills of quantities.

### **132.3 HOUSING ACCOMMODATION FOR ENGINEER'S JUNIOR STAFF**

The Contractor shall provide rent for the Engineer's junior staff.

### **132.4 LIST OF FURNITURE FOR ENGINEER'S STAFF HOUSES**

The contractor shall provide new furniture, equipment and fittings to the approval of the Engineer.

All the furniture mentioned below shall revert to the contractor after the completion of the contract.

New furniture to the approval of the Supervisor shall be provided in each staff house on the following scale:

<b><u>SCALE OF FURNITURE</u></b>	<b><u>TYPE I</u></b>
Double bed with mattress, pillows, sheets and blankets	1
Single bed with mattress, pillows, sheets and blankets	4
Dressing table with mirror	2
Stool (for dressing table	2
Chest of 5 No. drawers (with mirrors)	2
Wardrobe (built-in or movable)	4
Bedside cabinet	4
Bedside light	4
Stool (for bathroom)	1
Towel rail	4
Bedroom chair	4
Dining table	1
Dining chairs	6
Side board	1
Settee (7-seats)	1
Armchair with cushions	4
Coffee Table	1

Occasional tables	3
Bookcase	1
Standard lamp	2
Writing table with chair	1
Water filter	1
Refrigeration (400 litre capacity) incl. 1 deep freeze Compartment (100 litre capacity)	1
Lampshades	For all lights
Curtains with pelmets windows	On all
External security lights	4
Dustbins	2
Electric Cooker (with four rings, grill and oven) or Gas Cooker (four burners, grill and oven, with two gas cylinders)	1
Kitchen shelves (per sq.m)	2
Kitchen Table	1
Kitchen chairs	5
Electric Kettle	1
Glass ware, cutlery, crockery, kitchen utensils, etc. for 6 persons	

#### **SCALE OF FURNITURE**

#### **TYPE II**

Double bed with mattress, pillows, sheets and blankets	1
Single bed with mattress, pillows, sheets and blankets	3
Dressing table with mirror	1
Stool (for dressing table)	2
Chest of 5 No. drawers (with mirrors)	2
Wardrobe (built-in or movable)	3
Bedside cabinet	3
Bedside light	3
Stool (for bathroom)	1
Towel rail	3
Bedroom chair	3
Dining table	1
Dining chairs	6
Side board	1
Settee (5-seats)	1
Armchair with cushions	3
Coffee Table	1

Occasional tables	2
Bookcase	1
Standard lamp	2
Writing table with chair	1
Water filter	1
Refrigeration (400 litre capacity) incl. a deep freeze Compartment (100 litre capacity)	1
Lampshades	For all lights
Curtains with pelmets windows	On all
External security lights	2
Dustbins	1
Electric Cooker (with four rings, grill and oven) or Gas Cooker (four burners, grill and oven, with two gas cylinders)	1
Kitchen shelves (per sq.m)	2
Kitchen Table	1
Kitchen chairs	4
Electric Kettle	1
Glass ware, cutlery, crockery, kitchen utensils, etc. for 6 persons	

### **SCALE OF FURNITURE**

### **TYPE III**

Single bed with mattress, pillows, sheets and blankets	3
Chest of drawers (with mirrors)	2
Bedside cabinet	3
Bedside light	3
Bedroom chair	2
Wardrobe (built-in or movable)	2
Towel rail	2
Dining table	1
Dining chairs	4
Side board	1
Settee (3-seats)	1
Coffee Table	1
Occasional tables	1
Bookcase	1
Standard lamp	2
Writing table	1
Kitchen Cabinet	1

Water filter	1
Refrigeration (300 litre capacity) incl. a deep freeze Compartment (100 litre capacity)	1
Lampshades	For all lights
Curtains with pelmets windows	On all
External security lights	2
Dustbins	1
Electric Stove (with four rings, grill and oven) or Gas Stove (four burners, grill and oven, with two gas cylinders)	1 1
Glass ware, cutlery, crockery, kitchen utensils, etc. for 6 persons	

#### **SCALE OF FURNITURE**

#### **TYPE IV**

Single bed with mattress, pillows, sheets and blankets	2
Chest of drawers (with mirrors)	1
Bedside cabinet	2
Bedside light	2
Bedroom chair	2
Wardrobe (built-in or movable)	1
Towel rail	1
Dining table	1
Dining chairs	4
Side board	1
Standard lamp	2
Writing table with chair	1
Kitchen Cabinet	1
Water filter	1
Refrigeration (200 litre capacity)	1
Lampshades	For all lights
Curtains with pelmets windows	On all
External security lights	2
Dustbins	1
Electric Stove (with 3 rings) or Gas Stove (two burners, with one gas cylinder)	1 1
Glass ware, cutlery, crockery, kitchen utensils, etc. for 6 persons	

#### **SCALE OF FURNITURE**

#### **TYPE V**

Single bed with mattress, pillows, sheets and blankets	1
--	---

Chest of drawers (with mirrors)	1
Bedside light	2
Wardrobe (built-in or movable)	1
Towel rail	1
Dining table	1
Dining chairs	4
Side board	1
Standard lamp	2
Kitchen Cabinet	1
Water filter	1
Refrigeration (200 litre capacity)	1
Lampshades	For all lights
Curtains with pelmets windows	On all
External security lights	2
Dustbins	1
Electric Stove (with 3 rings)	1
or Gas Stove (two burners, with one gas cylinder)	1

All furniture mentioned above shall revert to the contractor after the completion of the contract.

Payments shall be made under the relevant provisions in the Bills of Quantities.

### **132.7 ENGINEER'S OFFICE, FURNITURE AND EQUIPMENT**

The Contractor shall provide a furnished and equipped main office of plan area not smaller than **160 metre squares** that is equivalent of the MOR Standard Resident Engineer's Office. This office shall be of weather-proof construction, provided with mosquito proof and burglar-proof windows and lockable doors and suitably insulated against heat and cold, all to the satisfaction of the Engineer. The room to be occupied by the Engineer's Representative and its front office shall be provided with a floor carpet to be approved by the Engineer. All other floors shall be given a PVC tile finish using approved adhesive including 150mm wood skirting or superior finish. The windows shall be fitted with curtains and blinders.

The office for the Resident Engineer shall be completely separate from that of the Contractor.

Latrines and washrooms graded to staff seniority, together with a drinkable water supply and waterborne sewage disposal shall be provided for the office. The Contractor shall also provide 24 hours a day security and electricity supply to the offices and shall allow for any water and electricity consumed and for any statutory charges associated.

The main office shall revert to the Contractor at the end of the project.

The Contractor may be instructed by the Engineer under clause 58 of the General Conditions of Contract to make payments of general receipted accounts for such items as stationery, stores, furniture and equipment, claims and allowances for supervision personnel and any miscellaneous claims or the Engineer may direct the

Contractor to purchase or pay for the above. The Contractor will, on provision of receipts, be paid under appropriate bill items in the BOQ.

Further, the Contractor shall, as provided for in the Bills of Quantities provide and maintain the listed office furniture and equipment as specified in the Appendix to Bill item 1.03 of Bill of Quantities with a dealer's certificate and warranty accompanying the furniture and equipment.

All office furniture and equipment bought under the Contract shall revert to the Employer at the end of the project. Payment for provision of the office including the furniture shall be paid against the appropriate bill items in the BOQ.

### **132.7 ENGINEER'S LABORATORY AND SURVEY EQUIPMENT**

The Contractor shall provide Engineer's laboratory as shown in the Book of Drawings and provide all the laboratory equipment, reagents and survey equipments as required by the Engineer. The Contractor shall be paid under appropriate bill items in the Bills of Quantities or on provision of receipts as required by the Engineer.

The Contractor may be directed to pay for stationery, equipment or reagents that are foresaid and also pay for servicing and repair of the laboratory equipment being used on the project.

The Contractor shall provide, install and maintain in a good state of repair, such laboratory, survey and other equipment as listed for the duration of the contract.

Such equipment shall be of approved manufacture, and shall be made available to the Engineer for the Engineer's exclusive use throughout the Contract, not later than three (3) weeks after the Engineer's order to supply. All equipment shall be ready to use and complete to perform the tests. The equipment shall revert to the Employer on completion of the Contract

Any delays to the Contractor or the Contractor's activities caused by the Engineer being unable to perform survey work, field or laboratory tests due to the Contractor's failure to supply and/or maintain the said equipment shall be deemed to have been caused entirely by the Contractor's own actions, and any consequences of such delays shall be interpreted as such.

The payment to comply with this requirement is provided in the Bill of Quantities and ownership of all equipment shall revert to the Employer after the completion of the Works.

Failure by the Contractor to provide or maintain the equipment shall make him responsible to bear all costs that may be incurred as a result of the Engineer's staff using alternative means of communication, including delays in supervision and approval of Works by the Engineer. List of Laboratory and Survey Equipment shall revert to the Employer at the end of the Contract.

The laboratory equipment shall be purpose-made for use in highways materials testing laboratories and shall comply with the relevant British (BS) or American (AASHTO) Standards.

#### **Resident Engineer's Laboratory Furniture and Equipment**

As listed in Appendix to Item 01-80-032 and 01-80-033 of the bills of quantities.

## **Resident Engineer's Survey Equipment**

As listed in Appendix to Item 01-80-034 of the bills of quantities.

### **132.1 ENGINEER'S REPRESENTATIVE OFFICE**

The Contractor may be instructed by the Engineer under clause 58 of the General Conditions of Contract to make payments of general receipted accounts for such items as stationery, stores, furniture and equipment, claims and allowances for supervision personnel and any miscellaneous claims or the Engineer may direct the Contractor to purchase or pay for the above. The Contractor will, on provision of receipts, be paid under appropriate bill items in the BoQ.

The Contractor, when instructed, shall provide and install at the Engineer's office the Equipment specified below with a dealer's certificate and warranty:

15. Three years warranty

### **132.3 COMMUNICATION FOR THE ENGINEER**

#### **Internet and e-mail services**

Where directed, the contractor shall provide 24 hours terrestrial or wireless internet connectivity with minimum throughput speed of 128kilobytes per second for the exclusive use by the Engineer, including all accessories and Terminal Equipment and pay for all associated installation, maintenance and usage charges throughout the duration of the contract.

The contractor shall allow for the provision and maintenance of internet connectivity and associated costs as per Appendix to item 01-80-026 of the Bills of Quantities.

### **137 ATTENDANCE UPON THE ENGINEER AND HIS STAFF**

The costs, for attendance required by this Clause 137, shall be as specified in the attached table:-

<u>Designation</u>	<u>Number</u>
Resident Engineer	1
Assistant Resident Engineer	1
Materials Engineer	1
Surveyor	1
Senior Inspector	1
Senior Lab. Technologist	1
Inspectors	4
Lab Technician	3
CAD Technician	1
Chain Men	2
Leveller	1

and shall be paid for under Item 01-80-030A of the Bill of Quantities.

In addition to the above listed staff, the Employer will attach under training or internship/Industrial attachment additional number of technical staff comprising Engineers, Inspectors, Surveyors and Materials Technologists. These staff shall be paid a stipend as shall be directed by the Engineer and the Contractor shall be reimbursed under Item 01-50-002 of the Bill of Quantities.

### **138 VEHICLES AND DRIVERS FOR THE ENGINEER AND HIS STAFF AND METHOD OF PAYMENT**

In addition to provisions of the Clause 138 of the Standard Specification, the Contractor shall when instructed to do so provide, fuel and maintain in good working conditions, with driver, the number and type of vehicle specified in the **Bill of Quantities** for exclusive use of the Engineer and his staff throughout the Contract.

The Contractor shall insure comprehensively the vehicles for any licensed driver and shall provide competent drivers during normal working hours and whenever required by the Engineer.

Should any vehicle supplied not be in road worthy condition, the Contractor shall provide equivalent replacement vehicle until such time as the original vehicle is repaired to the satisfaction of the Engineer and returned for use.

Payment for the vehicles up to 4,000Km shall be by months. Payment for mileage above 4,000Km shall be made at a rate per kilometer. The payment shall be inclusive of all fuels, lubricants, servicing, insurance, maintenance, drivers and repairs. The rate shall include any overtime the driver might be due or any other allowance to the normal working hours. Payment shall be made under relevant items in Bills of Quantities No. 1.

The vehicles provided under this clause shall revert to the Contractor.

### **139 MISCELLANEOUS ACCOUNTS**

The Contractor maybe instructed by the Engineer to make payments of general miscellaneous accounts for such items as stationary, stores and equipment and miscellaneous supervision personnel and claims or the Engineer may direct the Contractor to purchase or pay for the above. The Contractor will be paid on a prime cost basis plus a percentage for overheads and profits under appropriate items in the Bills of Quantities.

#### **140 PAYMENT OF OVERTIME FOR ENGINEER'S JUNIOR STAFF**

If the Contractor wishes to execute permanent work outside the Engineer's normal working hours, as stated in Clause 108 of this Specification, then the payment for the overtime for Engineer's support staff shall be paid by the Contractor, at the latest Ministry of Labour rate.

#### **142 ENVIRONMENTAL PROTECTION (where applicable)**

The Contractor shall comply with the Statutory Regulations in force in Kenya regarding environmental protection and waste disposal, and shall liaise with the National Environmental Management Agency (NEMA).

Within four (4) weeks of the order to commence work, the Contractor shall prepare and submit a specific Environmental Management Plan for the project and his operations, relating to the approved Environmental Impact Assessment. The Environmental Management Plan shall outline potential environmental hazards and risks, and provide an action plan to deal with the hazards, minimise the risks, and mitigate adverse environmental impacts, and include a general decommissioning plan covering all relevant aspects of the project. The Environmental Management Plan shall identify monitoring indicators and reporting requirements.

The Contractor shall be required to submit environmental progress reports to the Engineer every three (3) months.

The Contractor shall ensure so far as is reasonably practicable and to the satisfaction of the Engineer; that the impact of the construction on the environment shall be kept to a minimum and that appropriate measures are taken to mitigate any adverse effects during the construction.

(a) The Contractor shall exercise care to preserve the natural landscape and shall conduct his construction operations so as to prevent any unnecessary destruction, scarring, or defacing of the natural surroundings in the vicinity of the work. Except where clearing is required for permanent works, all trees, native shrubbery, and vegetation shall be preserved and shall be protected from damage by the Contractor's construction operations and equipment. All unnecessary destruction, scarring, damage or defacing resulting from the Contractor's operations shall be repaired, replanted, reseeded or otherwise corrected as directed by the Engineer, and at the Contractor's expense.

(b) The Contractor shall ensure that measures are in place to control soil erosion and water pollution, by use of berms, dykes, silt fences, brush barriers, dams, sediment basins, filter mats, netting, gravel, mulches, grasses,

slope drains, contour banks, and other erosion control devices and methods. Temporary erosion control provisions shall be coordinated with permanent erosion control features to assure economical, effective and continuous measures throughout the period of the works. The Contractor's attention is drawn to the requirements of Clause 502, in that works need to be progressively finished so that permanent vegetation can establish quickly to mitigate soil erosion and erosion of drains.

- (c) The Contractor shall provide all the labour, equipment, materials, and means required and shall carry out proper and efficient measures wherever and as often as necessary to minimise the dust nuisance.
- (d) The Contractor shall comply with all applicable Kenyan laws, orders and regulations concerning the prevention, control and abatement of excessive noise. Blasting, use of jackhammers, pile driving, rock crushing, or any other activities producing high-intensity impact noise may be performed at night only upon approval of the Engineer.
- (e) Immediately after extraction of materials, all borrows pits shall be backfilled to the satisfaction of the Engineer. In particular borrow pits near the project road shall be backfilled in such a way that no water collects in them.
- (f) Spilling of bitumen fuels Oils and other pollutants shall be cleared up.
- (g) The Contractor's attention is drawn to the requirements of the Standard Specification in regard to the environment and in particular to the following clauses:
  - Clause 115: Construction Generally
  - Clause 116: Protection from Water
  - Clause 136: Removal of Camps
  - Clause 605: Safety and Public Health Requirements Clause
  - Clause 607: Site Clearance and Removal of Topsoil and Overburden
- (h) Payment in respect of this Clause 142 is included as a Lump Sum in the Bill of Quantities. Payment of the Lump Sum will be by equal monthly instalments over the period of the Contract excluding the Period of Maintenance. The total sum of the instalments shall not exceed the Lump Sum, and payment of the monthly instalment will only be made for that month if the Engineer is satisfied that the Contractor has fully complied with the requirements of Clause 142, otherwise the Contractor shall forfeit such instalment.

## **SECTION 2: MATERIALS AND TESTING OF MATERIALS**

### **205 SOILS AND GRAVEL**

All materials testing shall be in accordance with section 2 of the Standard Specifications

## **SECTION 3 - SETTING OUT & TOLERANCES**

### **301 SETTING OUT**

- a) In addition to the provisions of clause 3.01(a) if the traverse points to be used for the setting out are close to the existing carriageway and interfere with construction works then the Contractor will have to relocate them to a location where they will not be disturbed. The co-ordinates and heights of all traverse points so located shall be listed and provided to the Engineer for checking and/or approval. Contractor shall also monument the new centreline every 200m along straight and all salient points along curves by a pin in the concrete beacon before commencement of any works.

The road reserve boundary posts shall have 12mm diameter steel pins embedded in concrete, 200mm long with 25mm exposed to the air, sticking out from its top surface. This pin shall be co-ordinated and heighted and result of the same shall be provided to the Engineer for approval. Cost of these works shall be included in the rates as no separate item has been provided.

Commencement of the works shall not be permitted until this basic survey data has been provided and approved by the Engineer for at least 2 Kms of the road.

b) Detailed Setting Out

Reference pegs shall be 50mm by 50mm in section 600mm long driven 400mm firmly into ground and painted white above the ground. The offset from centre line shall be indicated by small nail 20mm to 25mm long with its head driven flush with the top of the peg.

Chainages, offset and reference elevation shall be clearly indicated to the sides of the peg to the satisfaction of the Engineer.

After cutting of benches and prior to commencement of earthworks or subgrade works, Contractor shall take cross-sections again and submit the copy of the same to Engineer for agreement. These cross-sections shall then be used as basis of measurement for all subsequent layers, unless otherwise stated.

## **SECTION 4- SITE CLEARANCE AND TOP SOIL STRIPPING**

### **401 SITE CLEARANCE**

Site Clearance shall be carried out as directed by the Engineer.

### **REMOVAL OF TOPSOIL**

Topsoil shall include up to 200mm depth of any unsuitable material encountered in existing or newly constructed drains, drainage channels, and accesses.

## SECTION 5: EARTHWORKS

### 504 PREPARATION PRIOR TO FORMING EMBANKMENT

Where benching of the existing pavement is required to accommodate earthworks subgrade or subbase for widening of the road, the rate for compaction of existing ground shall be deemed to cover this activity.

Excavation in the pavement of the existing road shall be kept dry. In the event of water penetrating the underlying layer, construction of the subsequent layers shall be postponed until the underlying layers are dry enough to accommodate the construction plant without deforming or otherwise showing distress.

Step construction shall be carried out per layer at the joint where excavating both vertically and perpendicular to the direction of the travel. The step shall be 500mm perpendicular to the direction of the travel and 150mm vertical unless otherwise instructed by the Engineer.

Special care shall be taken when compacting the new material at the joint ensuring that specified density is achieved.

### 505 CONSTRUCTION OF EMBANKMENTS

Only material approved by the Engineer shall be used for fill in embankments.

Material with high swelling characteristics or high organic matter content and any other undesirable material shall not be used, unless specifically directed by the Engineer. Unsuitable material shall include:

- (i) All material containing more than 5% by weight or organic matter (such as topsoil, material from swamps, mud, logs, stumps and other perishable material)
  - (ii) All material with a swell of more than 3% (such as black cotton soil)
  - (iii) All clay of plasticity index exceeding 50.
- (i) All material having moisture content greater than 105% of optimum moisture content (Standard Compaction)

**Subgrade:** Shall mean upper 300mm of earthworks either in-situ or in fill and subgrade shall be provided for as part of earthworks operation and payment shall be made as “fill”. The material for subgrade shall have a CBR of not less than 8% measured after a 4-day soak in a laboratory mix compacted to a dry density of 100% MDD (AASHTO T99) and a swell of less than 1%.

**Subgrade repair:** Where directed by the Engineer, any localized failure in the subgrade shall be repaired by filling in selected soft, hard or natural of minimum CBR 30% and compacted in accordance with clauses in the specifications applying to normal subgrade.

**Embankment repair:** Where directed by the Engineer, any localized filling in soft, hard or natural; selected material requirements shall be executed with Clause 505.

## **508    COMPACTION OF EARTHWORKS**

At pipe culverts, all fill above ground level around the culverts shall be compacted to density of 100% MDD (AASHTO T.99) up to the level of the top of the pipes or top of the surround(s), if any and for a width equal to the internal diameter of the pipe on either side of the pipe(s) or surround(s) as applicable.

At locations adjacent to structures, all fill above ground level up to the underside of the subgrade shall be compacted to density of 105% MDD (AASHTO T.99). In case of fill around box culverts this should be carried out for the full width of the fill and for a length bounded by the vertical plane passing through the ends of the wing-walls.

Notwithstanding the provision of clause 503 of the standard Specification, Compaction of subgrade material (i.e. material immediately below formation) in cut areas shall not be carried out by the contractor in areas where the formation is formed in hard material, unless the Engineer issues specific instructions to the contrary are issued.

Where improved sub-grade material shall be required, this shall be compacted and finished to the same standards and tolerances as those required for normal subgrade and clauses in the specifications applying to normal subgrade shall also apply.

## **511    BORROW PITS**

*The first part of the Standard Specification is amended as follows: -*

Fill material which is required in addition to that provided by excavation shall be obtained from borrow pits to be located and provided by the Contractor but to the approval of the Engineer contrary to what has been stated.

## **517    MEASUREMENT AND PAYMENT**

Notwithstanding the provisions of clause 517 of the standard specifications, the rate for compaction of fill in soft material shall allow for the requirements of clause 508 of the special specification and no extra payment shall be made for compaction around pipe culverts (100% MDD AASHTO T.99).

## **SECTION 6 - QUARRIES, BORROW PITS, STOCKPILES AND SPOIL AREAS**

### **601 GENERAL**

Notwithstanding any indications to the contrary in the Standard specification the Engineer will not make available to the Contractor any land for quarries, borrow pits, stockpiles and spoil areas, except for those areas in road reserves specifically approved by him.

The contractor will be entirely responsible for locating suitable sources of materials complying with the Standard and Special Specifications, and for the procurement, Wining, haulage to site of these materials and all costs involved therein. Similarly the contractor will be responsible for the provision and costs involved in providing suitable areas for stockpiling materials and spoil dumps. Should there be suitable sites for spoil dumps or stockpiles within the road reserve forming the site of the works the Contractor may utilise these subject to the approval of the Engineer.

No additional payment will be made to the Contractor to cover costs arising from the requirements for this Clause and the Contractor must include these costs in the rates inserted into the Bills of Quantities.

### **602 MATERIAL SITES**

The information on possible material sites is given for the general guidance of bidders. Bidders are however advised to conduct their own investigation as the information contained therein is neither guaranteed nor warranted

### **603 PROVISION OF LAND**

Notwithstanding any indications to the contrary in the Standard specification the Engineer will not make available to the Contractor any land for quarries, borrow pits, stockpiles and spoil areas, except for those areas in road reserves specifically approved by him.

The contractor will be entirely responsible for locating suitable sources of materials complying with the Standard and Special Specifications, and for the procurement, Wining, haulage to site of these materials and all costs involved therein. Similarly the contractor will be responsible for the provision and costs involved in providing suitable areas for stockpiling materials and spoil dumps. Should there be suitable sites for spoil dumps or stockpiles within the road reserve forming the site of the works the Contractor may utilise these subject to the approval of the Engineer.

No additional payment will be made to the Contractor to cover costs arising from the requirements for this Clause and the Contractor must include these costs in the rates inserted into the Bills of Quantities.

## **605 SAFETY AND PUBLIC HEALTH REQUIREMENTS**

In addition to clause 605, the contractor shall allow for professionals to conduct lectures to the workers regarding the spread of HIV/Aids.

## **SECTION 7 - EXCAVATION AND FILLING FOR STRUCTURES**

### **703 EXCAVATION OF FOUNDATIONS FOR STRUCTURES**

Unless otherwise instructed by the Engineer, all excavated surfaces in material other than hard material, on which foundations for structures shall be placed, shall be compacted to 100% MDD (AASHTO T.99) immediately before structures are constructed.

Thus in Standard Specification, Paragraph 4, last line: - Replace "95%" with "100%".

### **707 BACKFILLING FOR STRUCTURES**

Unless otherwise instructed by the Engineer, all backfilling material shall be compacted to a minimum of 100% MDD (AASHTO T.99).

### **709 EXCAVATION FOR RIVER TRAINING AND NEW WATER COURSES**

Payments for river training and establishment of new watercourses shall only be made where such work constitute permanent works. Works done for road deviation or other temporary works shall not qualify for payment.

### **712 RIP-RAP PROTECTION WORK**

Quarry waste or similar approved material shall be used to backfill scoured and eroded side, outfall and cut-off drain. The material shall be compacted to form a flat or curved surface preparatory to stone [pitching of drainage channels, existing and new scour checks as directed by the Engineer.

The surface to receive the pitching shall be compacted and trimmed to slope and the stone hand laid, interlocked and rammed into the material to give an even finished surface. The interstices of the Pitching shall be rammed with insitu material. The insitu material immediately behind the pitching shall be compacted to minimum density of 100% MDD compaction (AASHTO T.99)

### **714 BACKFILL BELOW STRUCTURES**

Where instructed this shall be carried out in compliance with the requirements of Clause 507 and 804 of the Standard Specification.

## **SECTION 8 - CULVERTS AND DRAINAGE WORKS**

### **801 SCOPE OF SECTION**

The operations specified in this section apply to the installation of drainage works and reinstatement and improvement of the same.

In addition, this Section covers: -

- Extending of existing 450mm, 600mm and 900mm diameter pipes to be compatible with the increased road width or access.
  
- Desilting and cleaning of existing pipes and outfall drains to make them free flowing.

### **804 EXCAVATION FOR CULVERTS AND DRAINAGE WORKS**

In the Standard Specifications, make the following amendments: -

- (a) In paragraph 6, line 3, and in paragraph 7, line 5 and in paragraph 11, line 6, delete "95%" and insert "100%".
  
- (b) Removal of Existing Pipe Culverts

Where instructed by the Engineer, the Contractor shall excavate and remove all existing blocked or collapsed culvert pipes of 450mm, 600mm and 900mm diameter including concrete surround, bedding, inlet and outlet structure.

The void left after removal of culvert pipes shall be widened as necessary to accommodate new concrete bedding, pipe and haunching.

The payment of this work shall be per linear metre of pipes removed, and the volume in m<sup>3</sup> of inlet/outlet structure removed. The void left by removal of these pipes shall be carefully preserved in order to accommodate replacement of 450mm, 600mm or 900mm diameter pipe culverts as shall be directed by the Engineer.

- (c) Removal of Other Existing Drainage Structures

When instructed by the Engineer, the Contractor shall demolish or remove any other structure and payment for this shall be made on day work basis.

(d) Excavation for Culverts and Drainage Works

The Contractor shall carry out all excavations for new culverts and drainage works to the lines, levels, inclinations, and dimensions shown on the drawings or as instructed by the Engineer.

## **805 EXCAVATION IN HARD MATERIAL**

In the Standard Specifications, Sub-clauses 805(a) and 805 (b) delete "95%" and insert "100%".

In sub-clause 809(a), paragraph 1, line 1, substitute "95%" with "100%".

In sub-clause 809(c), paragraph 2, line 4, between the words "compacted" and "and shaped" insert the words "to 100% MDD (AASHTO T.99)".

Hard material is material that can be excavated only after blasting with explosives or barring and wedging or the use of a mechanical breaker fitted with a rock point in good condition and operated correctly. Boulders of more than 0.2m<sup>3</sup> occurring in soft material shall be classified as hard material.

## **809 BEDDING AND LAYING OF PIPE CULVERTS**

Concrete pipes shall be laid on a 150mm thick concrete bed of class 15/20 and the pipes shall be bedded on a 1:3 cement: sand mortar at least 50mm thick, 150mm wide and extending the full length of the barrel.

The rates inserted shall allow for compaction of the bottom of excavation to 100% MDD (AASHTO T.99).

## **810 JOINTING CONCRETE PIPES**

The concrete pipes for the culverts shall have ogee joints and will be jointed by 1:2 cement: sand mortar and provided with fillets on the outside as described in clause 810 of the Standard Specification.

## **812 BACKFILLING OVER PIPE CULVERTS**

In the Standard Specifications, clause 812

- a) Wherever the expression "dry density of 95% MDD (AASHTO T. 99)" occurs delete and replace with "dry density of 100% MDD (AASHTO T.99)".

The rates entered for laying of pipe culverts shall allow for backfilling to pipe culverts and compacting to 100% MDD (AASHTO T.99) and these works shall not be measured and paid for separately.

## **814 SUBSOIL DRAINS**

In the event of excavation for repairs exposing local seepage, springs or unacceptably high water table, the Engineer may instruct the provision of counter fort or French drains.

These drains shall consist of a trench excavated to the alignment, width, depth and gradient instructed by the Engineer, and backfilled with approved compacted clean hard crushed rock material as specified in clause 815 of the standard specification. Where these drains lie within the carriageway the carriageway shall be reinstated with compacted stabilised gravel and surfaced with hot asphalt or a surface dressing as instructed by the Engineer.

## **815 INVERT BLOCK DRAINS AND HALF ROUND CHANNELS**

Invert Block Drains and Half Round Channels shall be constructed as shown in the drawings provided in accordance with the Standard Specifications where directed by the Engineer.

## **817 REPAIRS TO DRAINS**

### **817.1 Cleaning, construction and Repair of Existing Drains**

In areas of existing side drains, mitre or outfall drains where such are blocked, the Engineer shall instruct the Contractor to clean and clear the drains to free flowing condition.

The work shall consist of:

- (a) Stripping and removal of any extraneous material to spoil including vegetation and roots in the drains to the satisfaction of the engineer.
- (b) Spreading of any spoil to the satisfaction of the Engineer.

Shaping the drains to free flowing condition as directed by the Engineer and:-

- i. Removing any broken side slabs for inverted block drains and replacing with new ones.
- ii. Or removing any broken inverted block drains and replacing with Concrete class 20/20 and A142 BRC reinforcement.

Measurement and Payment for cleaning drains shall be by linear metre of drain cleaned measured as the product of plan area and vertical depth of extraneous material instructed to be removed. Where insitu concrete is used measurement will be on cubic metre of concrete and BRC area or weight in relevant unit eg Kg, Tonnes etc. No extra payment will be made for removal of vegetation and roots.

## **817.2 Channels**

The Engineer may instruct that the Contractor provides open channels in place of existing subdrains where the latter may be damaged or in any other place. The rates entered by the Contractor in the bills of quantities must include for removal and disposal of any subdrain material, excavation to line and level, backfilling and compaction as directed by the engineer. The channels shall be constructed of precast class 20/20 concrete of minimum 80mm thickness and lengths or widths not exceeding 1000mm. Joints shall be at least 15mm wide filled with 1:2 cement sand mortar.

## **817.3 Rubble fills for protection work**

Quarry waste or similar approved material shall be used to back fill scoured and eroded side, outfall and cut-off drains. The material shall be compacted to form a flat or curved surface preparatory to stone pitching of drainage channels, existing and new scour checks as directed by the Engineer.

## **817.5 Gabions**

Gabions shall be constructed in accordance with clause 711 of the standard Specification.

## **817.6 Spoil Material**

The Contractor shall be responsible for removal from site of all materials excavated in the course of undertaking works in this section of the specifications, unless suitable for re-use, and deposit of the material in a spoil dump to be approved by the Engineer.

## **818 SCOUR CHECKS**

Scour checks are to be constructed in mass concrete in accordance with clause 818 of the standard Specifications and the drawings as shall be provided.

## **819 CLEANING AND MAINTENANCE**

### **819.1 Desilting of Pipe Culverts**

Where instructed, Contractor shall desilt the existing pipe culverts by removing all the material from the pipe to make them clean and free flowing.

Measurement and payment shall be by the linear metres of pipes de-silted, regardless of diameter size.

## **SECTION 9 - PASSAGE OF TRAFFIC**

### **903 MAINTENANCE OF EXISTING ROADS**

The Contractor shall maintain the existing project road a head of works using compacted asphalt concrete type I in accordance with the provisions in clause 1601B – 1607B of the Special Specifications or gravel material depending on the nature of the wearing course surface.

### **904 CONSTRUCTION OF DEVIATIONS**

#### **(a) General**

In addition to requirement of this clause, the Contractor shall construct and complete deviations to the satisfaction of the Engineer before commencing any permanent work on the existing road. Also during these works the contractor is supposed to provide a detour of adequate pipe culverts for pedestrian and traffic crossing where there is bridge works.

Subject to the approval by the Engineer, the Contractor may maintain and use existing roads for deviation. Payment for this, made in accordance with clause 912 (a) (i), shall be by the Kilometre used depending on the type of road used, whether bituminous or earth/gravel. The rates shall include for the provision of materials and the works involved.

#### **b) Geometry**

- i. The carriageway width of the deviations shall not be less than 6m wide and suitable for 2-way lorry traffic unless otherwise specified.
- ii. The carriageway width of the deviations shall not be less than 3.5 m wide and suitable for 1-way lorry traffic unless otherwise specified.

#### **c) Construction**

Unless otherwise instructed gravel wearing course for the deviation shall be 150 mm compacted thicknesses complying with section 10 of the Standard Specification. The CBR at 4 day soak shall not be less than 25 and the PI range shall be 15- 20. The Contractor shall allow in his rate for removal of any unsuitable material before placing of gravel wearing course, as this will not be paid for separately.

In addition to provision of this clause, Contractor is required to sprinkle water at least 4 times a day at the rate of 1 to 1.4 litres/Square meter in regular interval to minimise the effects of dust. Latest sprinkling time shall be one hour before the sunset.

Where existing neighbouring roads are used as deviation, Contractor shall carry out repairs and maintenance in parent materials used for the existing base and surfacing of the road being used.

## **906 PASSAGE OF TRAFFIC THROUGH THE WORKS**

The Contractor shall arrange for passage of traffic through the works during construction whenever it is not practicable to make deviations.

Any damage caused by passing traffic through the works shall be made good at the contractor's own cost.

## **907 SIGNS, BARRIERS AND LIGHTS**

Contractor shall provide signs, barriers and lights as shown in the drawing in Book of Drawings at the locations where the traffic is being carried off the existing road to the deviation and back again to existing road. The Contractor shall provide ramps and carry out any other measures as instructed by the Engineer to safely carry traffic from the road to deviation.

Contrary to what has been specified in this clause the road signs provided shall be fully reflectorized and in conformity with clause 9.1 of the "Manual for Traffic Signs in Kenya Part II".

## **909 ASSISTANCE TO PUBLIC**

In addition to provision of clause 909, Contractor shall maintain close liaison with the relevant authorities to clear any broken down or accident vehicles from the deviations and the main road, in order to maintain smooth and safe flow of the traffic. Further, the Contractor shall provide a traffic management plan to be approved by the Engineer before the commencement of any construction works and execute the same, to the satisfaction of the Engineer, during the entire period of project implementation. **A draft traffic management plan shall be submitted with Bid.**

## **912 MEASUREMENT AND PAYMENT**

### **Construct Deviation**

#### **Road Deviation**

The Contractor shall be paid only 50% of the rate when he completes deviation road to the satisfaction of the Engineer. The balance shall be paid in equal monthly instalments over the contract period, as he satisfactorily maintains the deviation (as per clause 904 and 905 above) when it is in operation.

Where existing neighbouring road has been used as deviation, payment shall be by the kilometre rate and shall include the cost of repairs and maintenance of the road carried out in parent base and subbase materials.

### **Maintain existing road**

Asphalt Concrete or gravel for maintaining the existing road shall be measured by the cubic metre placed and compacted upon the road

### **Passage of traffic through the works**

Payment shall be made on Lump Sum basis.

### **Assistance to Public**

The Contractor will be deemed to have included cost of this item in other items and no separate payment shall be made.

## SECTION 10: GRADING AND GRAVELLING

### 1001 SCOPE:

Grading covers the works involved in the reinstatement of the carriageway to the camber by removing the high points and filling up gullies corrugations and wheel ruts to restore smooth running surface. Graveling consists of excavation, loading hauling and spreading of gravel wearing course material on the formation of carriageway. Gravel shall include lateritic gravel, quarzitic gravel, calcareous gravel, decomposed rock, soft stone coral rag, clayey sand and crushed rock.

The material may be obtained from borrow pits or excavation in cuttings. Gravel material shall conform to the requirement given in Table 10.1

**Table 10.1: Requirement for Gravel Wearing Course**

<b>GRADING REQUIREMENTS AFTER COMPACTION</b>		<b>PLASTICITY REQUIREMENTS PI</b>		
Sieve (mm)	% by Weight Passing	Zone	Min	Max
40	100	WET	5	20
28	95 – 100			
20	85 – 100	DRY	15	20
14	65 – 100			
10	55 – 100			
5	35 – 92			
2	23 – 77	<b>BEARING STRENGTH</b>		
1	18 – 62	Traffic VPD	CBR	DCP Equivalent mm/Blow
0.425	14 – 50	Greater than 15	25	11
0.075	10 – 40	Less than 15	20	14
CBR at 95 % at MDD, Modified AASHTO and 4 days soak				
Lower quality material (CBR 15) may be accepted if no better material can be found				

NB: Wet Zone - mean annual rainfall greater than 500 mm.

Dry zone - mean annual rainfall less than 500 mm.

The Engineer shall approve quarries and their extent of exploitation. The quarries shall be shown to the Contractor prior to commencement of the Works. The Contractor shall be responsible for the acquisition of the quarry rights and shall therefore conduct respective negotiations with landowners and affected communities.

Alternative sources of gravel material whose quality can be shown to be in compliance with the specification requirements may be used, with the proviso that the Employer is not to incur additional expenses in connection with its winning and haulage. Contractor is deemed to have included in his rates for the provision of the gravel material to have included the cost of complying with the testing requirements.

## **1002 Removal of Overburden**

The Item consists of excavation of overburden including loading, hauling and stockpiling at the approved locations. The thickness of the overburden layer to be removed shall be determined from the depths of the trial pits dug at a 30m grid within the quarry area.

The overburden shall be removed and deposited neatly in order to use it again to reinstate the quarry at the end of improvement work.

### **Work Method:**

The contractor shall use **labour** or **equipment** to carry out this item of work

### **Quality Control**

- The location and manner of stock piling of the overburden for the reinstatement of the quarry shall be visually checked

### **Measurement and Payment**

No separate measurement and payment shall be made for removal of overburden and contractor shall be deemed to have allowed in his rates and prices for the cost.

## **1003 Excavation of Gravel**

The gravel shall be excavated from quarries approved by the Engineer. It is the Contractors obligation to inform the Engineer in the case that the quality / availability of the gravel changes during the course of excavation.

Oversize stones and boulders shall be removed from the excavated gravel and deposited outside the quarry at locations approved by the Engineer. Such stones and boulders may be reused for structures and scour checks

### **Work Method**

#### **(i) Labour based methods**

The contractor shall excavate and stockpile the gravel in bays for efficient loading by labour.

## **(ii) Equipment methods**

The Contractor shall excavate the gravel and stockpile in heap(s) for the efficient loading by equipment.

### **Quality Control**

- The widths of the loading bays shall be checked before excavation can commence.
- The loading bays shall be checked to ensure it is free draining.

### **Measurement and Payment**

No separate measurement and payment shall be made for excavation of gravel and contractor shall be deemed to have allowed in his rates and prices for the cost.

## **1004 Haulage**

This activity involves loading of excavated gravel, haulage by appropriate equipment and off-loading of the same as specified in the drawings or as directed by the Engineer. Where the loads delivered in any load falls short of agreed equipment capacity, dumping shall not be permitted unless the agreed spacing is adjusted accordingly.

Where loads supplied are found to contain material other than from the approved quarry and thus of unacceptable quality, the Engineer shall cause them to be removed from site at the contractor's expense.

### **Work Method**

The Contractor shall use a combination of both Labour and equipment to carry out this Item work.

### **Quality Control**

- No haulage equipment shall be used unless its capacity has been ascertained the Engineer.
- The quality of gravel dumped on the carriageway/carriageway shall be visually checked daily.
- The quantity of material delivered in each load shall be checked before dumping is allowed.
- The distance between the stacks shall be checked using tape measure.

## Measurement and Payment

No separate measurement and payment shall be made for haulage of gravel and contractor shall be deemed to have allowed in his rates and prices for the cost.

### 1005 Spreading and compaction of gravel

#### i. Labour methods

#### ii. Equipment methods

This activity involves spreading gravel material, shaping to ensure uniform thickness of the layer across the full width of the carriageway and to the specified camber. Spreading also includes, removing any oversized stones or boulders which cannot be broken down to required size, spoil dump.

Where water needs to be added, it shall be applied in an even manner and the rate of application shall be such that no transverse or longitudinal flows occur. Unless otherwise instructed by the Engineer, the moisture content shall be within the range of +/- 2% of the optimum moisture content. Compaction will be carried out as specified in 5.05.

#### Work Method

The Contractor shall use **Labour** or Equipment to carry out this Item work.

#### Quality Control

- The gravel surface width shall be checked at every 100m interval using tape measure and shall have tolerance of + / - 50mm.
- Trial holes at every 100m shall be used to check the gravel surface thickness and shall have a tolerance of + 5mm / - 0mm.
- The camber cross fall shall be checked at every 50m and the maximum tolerances shall be + / - 1 %
- The longitudinal profile shall be checked with every load to ensure a smooth surface with no corrugations or depressions

**Measurement:**                      **m<sup>3</sup>**

The unit of measurement shall be in cubic metres of compacted material on carriageway

## **Payment**

The unit rate shall be the full compensation for labour, tools, equipment and any incidental costs required for carrying out the work.

### **1006 Carriageway Grading**

#### **i)Light Grading**

This activity shall consist of trimming of the carriageway to control roughness and corrugations using either a towed grader or a motorized grader. The width of the carriageway shall be as specified in the drawings or as directed by the Engineer.

Pegs 200 to 300mm shall be placed at 10 to 20 m intervals to mark edge of the carriageway.

The material shall be bladed toward the center of the carriageway starting from both edges to the specified camber.

#### **Work Method**

The contractor shall use equipment to carry out this item work.

#### **Quality Control**

- The width of the carriageway shall be checked using tape measure at every 10m with tolerance of +50mm or -20mm.
- The camber shall be checked using camber board at every 5m with and shall have a tolerance of +/- 1%

**Measurement:**                      **m<sup>2</sup>**

The unit of measurement shall be square meters of carriageway graded.

Payment

The unit rate shall be the full compensation for labour, equipment and any incidental costs required for carrying out the work.

## **ii) Heavy Grading and Compaction**

This activity shall consist of scarifying of the existing carriageway/carriageway surface, cutting high spots and moving materials to fill potholes, corrugations and wheel ruts and reshaping of the surface to the specified camber, using either towed or motorized grader. All loose rocks, roots grasses shall be removed and disposed well clear of the drains.

Pegs 300 to 400mm shall be placed at 10 to 20 m intervals to mark edge of the carriageway.

The material shall be bladed toward the center of the carriageway starting from both edges until the specified camber is achieved. Compaction will be carried out as specified in 5.05.

### **Work Method**

The contractor shall use equipment to carry out this item work.

### **Quality Control**

- The width of the carriageway shall be checked using tape measure at every 10m with tolerance of + 50mm or -20mm.
- The camber shall be checked using camber board at every 5m with and shall have a tolerance of +/- 1%

**Measurement:**                    **m<sup>2</sup>**

The unit of measurement shall be square meters of carriageway graded.

### **Payment**

The unit rate shall be the full compensation for labour equipment and any incidental costs required for carrying out the work.

## **1007 Restoration of Quarries and Borrow pits**

The ground shall be levelled, topsoil hauled back and uniformly spread over the entire exposed/excavation area.

Adequate drainage provisions shall be made to protect excavation areas. Where necessary appropriate protection measures may be taken to avoid erosion of the spread topsoil layer. Grass and trees may be replanted as directed by the Engineer.

## **SECTION 11 – SHOULDERS TO PAVEMENT**

### **1101 GENERAL**

Shoulders shall be constructed in accordance with guidelines given in 1102 and as directed by the Engineer.

For sections where shoulders are extremely low and requires fill material before the shoulder is reconstructed, the construction of fill embankment shall be in accordance with Section 5 of this specification.

### **1102 MATERIAL FOR CONSTRUCTION OF SHOULDERS**

Low shoulder shall be reconstructed by cutting benches, filling and compacting approved fill material to form the formation to the shoulders.

The gravel material shall have a minimum CBR of 25 at 95% MDD (AASHTO T180) and 4 days soak. The gravel shall also be within a Plasticity Index of 15-20.

Shoulder reconstruction shall be same in all sections including the slip roads.

### **1106 MEASUREMENT AND PAYMENT**

Payment for shoulder construction shall be in accordance with the relevant clauses in the bill of quantities.

## **SECTION 12 - NATURAL MATERIAL SUBBASE AND BASE**

## **1201 GENERAL**

Where instructed by the Engineer, the Contractor shall undertake repairs, widening and reprocessing to the existing carriageway and shoulders in accordance with sections 12 and 14 of the Special Specifications.

### **a) Areas to be scarified and reprocessed**

The contractor will scarify, add new material and reprocess sections as determined by the Engineer.

### **b) Pavement repairs**

The Contractor will carry out repairs to base and subbase as directed by the Engineer and according to Specifications given in Sections 12 and 14 of the Standard Specifications.

### **c) Pavement widening**

The Contractor shall, as directed by the Engineer, bench and compact the subgrade to 100% MDD (AASHTO T99), provide lay and compact material for subbase and base as directed by the Engineer and in accordance with Sections 5 and 12 of the Standard Specifications.

## **1203 MATERIAL REQUIREMENTS**

Natural materials for base and subbase shall conform to the specifications given in Section 12 of the Standard Specifications for Road and Bridge Construction for cement and lime improved base and subbase.

## **1209 MEASUREMENT AND PAYMENT**

Natural material for subbase and base shall be measured by the cubic metre placed and compacted upon the road calculated as the product of the compacted sectional area laid and the length.

## **1210 HAND PACKED STONE**

Hand packed stone base is a layer of hand laid stone of defined size and durable in nature, laid in a manner such that when proof rolled and compacted it forms a stable and dense matrix as a road base.

### **a) Material for Hand Packed Stone Base**

This shall consist of durable stone with nominal base dimensions of 75 mm square and minimum height of 150 mm or when compacted to give a layer of 150 mm. The stone shall be class C with the following requirements:

<b>LAA</b>	<b>45 max</b>
<b>ACV</b>	<b>32 max</b>
<b>SSS</b>	<b>12 max</b>
<b>FI</b>	<b>30 max</b>
<b>CR</b>	<b>60 min.</b>

It shall be free from foreign matter. The fines passing 0.425 mm sieve shall be **NONPLASTIC**

**b) Laying**

The stone shall be laid by hand closely together. The stone shall be carefully bedded and tightly wedged with suitable spalls. The base of the stone shall alternate with the apex in all directions or as directed by the Engineer. The layer shall be proof rolled with a loaded scrapper or truck with a minimum axle load of 8 tonnes in the presence of the Engineer who shall approve of its stability before compaction.

**c) Compaction**

This shall be by a steel wheeled roller of at least five tonnes per metre width of roll. It shall consist of four static runs or until there is no movement under the roller. There shall follow vibratory compaction until an average dry density of 85% minimum of specific gravity of stone has been achieved. No result shall be below 82% of specific gravity. The surface of the compacted layer shall then be levelled by quarry dust (0/6 mm). The dust shall have the following specifications:

The stone shall be class C

**Grading**

<b>Sieve Size</b>	<b>% Passing</b>
10	100
6.3	90-100
4	75-95
2	50-70
1	33-50
0.425	20-33
0.300	16-28
0.150	10-20
0.075	6-12

The dust shall be free from foreign matter and fines passing 0.425 mm sieve shall be **NON-PLASTIC**. The maximum layer shall be 40 mm or as directed by the Engineer

**d) Measurement and Payment**

Payment shall be by the cubic metre laid (m<sup>3</sup>). Measurement of volume shall be determined as the product of length and compacted thickness laid. The rate quoted for this item should include the cost for laying the levelling quarry dust layer, as no extra payment shall be made for this layer.

**1211 REPROCESSING EXISTING PAVEMENT LAYERS**

**2.5.1 General**

The existing surfacing and the base shall be reprocessed with additional material and the composite mixture shall be compacted to form the subbase layer.

Before commencement of the work the Contractor shall propose plants and equipment he proposes to use for this activity.

The Contractor after approval of his proposal shall carry out test section in accordance with Section 3 of the Standard Specifications.

2.5.2 The existing surfacing and base course shall be broken up to specified depth and reprocessed in place, where required. The underlying layers shall not be damaged, and material from one layer may normally not be mixed with that of another layer. Where unauthorized mixing occurs or where the material is contaminated in any way by the actions of the Contractor, and the contaminated material does not meet the specified requirements of for the particular layer, he shall remove such material and replace it with other approved material, all at his own expense.

2.5.3 Any mixture composition of the new layer must not contain more than 30% of the bituminous material by volume. The mixture must not contain pieces of bound bituminous material larger than 37.5mm, and any such material shall be removed at the Contractor's cost.

2.5.4 The requirements for imported material used in the respective pavement layers shall comply with the limitations, norms, sizes and strengths specified in the Standard Specifications clause 1203(b) and (d) and shall be worked as per Section 14 of the Standard Specification.

2.5.5 Material reworked in-situ or that obtained from existing pavement is not expected to comply with the material requirements but the reworking should achieve the specified requirements.

2.5.6 Where the thickness of any existing pavement layer requires to be supplemented within reprocessing and the thickness of the additional material after compaction will be less than

100mm, the existing layer shall be scarified to a depth that will give a layer thickness of at least 100mm after compacting the loosened existing and the additional material.

### **Controlling the Reworked Depth**

The Contractor shall submit a proven method to method to control the depth of excavation, or layer to be reworked, to the Engineer for approval. The Engineer may order a trial section to be reprocessed before any major length of the road is rehabilitated.

### **Excavations**

Excavations in the pavement shall be kept dry. In the event of water penetrating the underlying layers, construction of the consecutive layers shall be postponed until the underlying layers are dry enough to accommodate the construction plant without deforming or otherwise showing distress.

Step construction shall be carried out per layer at the joint when excavating, both longitudinally (if appropriate) and perpendicular to the direction of travel. The step width shall be 500mm perpendicular to the direction of travel, and 150mm long longitudinally, unless otherwise instructed by the Engineer.

Special care shall be taken when compacting the new material at the joint, ensuring that the specified density is achieved.

### **Measurement and Payment**

(a) Item: In-situ reprocessing of existing pavement layers as subbase compacted to specified density (95% MDD AASHTO T180) and thickness.

Unit: M<sup>3</sup>

The tendered rate shall include full compensation for breaking up the existing pavement layer to specified depth, breaking down and preparing the material and the spreading and mixing in of any additional material

(b) Item: The addition of extra gravel to subbase.

Unit: M<sup>3</sup>

The tendered rate shall include full compensation for procuring and addition of the material to the in-situ scarified layers and the transportation of the material over unlimited free-haul distance. The tendered rates will also include full compensation for prospecting for materials and any payments necessary to acquire the specified quality material.

(c) Excavation of existing bituminous pavement materials including unlimited free-haul.

Unit: M<sup>3</sup>

The tendered rates shall include full compensation for excavating the existing bituminous material from the pavement layers and for loading, transporting the material for unlimited free-haul, off-loading and disposing of the materials as specified.

(d) Excavation of the existing pavement

Unit: M<sup>3</sup>

The tendered rate shall include full compensation for excavating the existing material from the pavement layers and for loading, transporting the material for unlimited free-haul distance, off-loading and disposing of the material as specified.

Payment will only be made for breaking up and excavating existing pavement layers to the specified depth if the material is to be removed to spoil.

## **SECTION 14: CEMENT TREATED MATERIALS**

### **1401. Cement Treatment**

Cement for stabilization will be CEM 1 Portland cement conforming to KS 1262. The cement content of the stabilized material shall be as indicated by the Engineer and will normally be about 4%. The Engineer shall exercise his discretion to any variation in the rate of application of the cement, which he may see fit, to order from time to time.

#### **Moisture Content**

The moisture content of the stabilized material shall be as directed by the Engineer but nevertheless within the range of 85% to 100% of the optimum Moisture Content (AASHTO T.180)

#### **Mixing and Placing**

The material to be stabilized and the cement shall be mixed by an approved mixing plant, which will either be a mix-in-place pulvimixer or a stationary mixing plant for material to be used for pavement reconstruction, widening and shoulders.

### **1403. Lime Improvement**

Lime improvement shall be carried out in accordance with Section 14 of the Standard Specification.

#### **1409. Protection & Curing**

Protection and curing shall be carried out in accordance with the provisions of Clause 1409(i) of the Standard Specification but provision shall be made to wet the surface from time to time as directed by the Engineer.

#### **1410. Traffic**

The requirements of clause 1410 of the Standard Specification will not apply to improved natural material utilized for patching and repair works but will apply in case reprocessing of reconstruction and widening of the existing base and shoulders.

### **SECTION 15 - BITUMINOUS SURFACE TREATMENTS**

#### **1501B PREPARATION OF SURFACE**

In addition to requirements of Clause 1503B of the Standard Specifications, the contractor shall prepare and Repair Cracks, Edges, Potholes and Other Failures as follows: -

a) **Cracks 3.0mm or less in width**

The entire crack area shall be cleaned by brushing with a wire brush and then blowing with a compressed air jet and the crack sealed with 80/100 cutback bitumen using a pouring pot or pressure lance and hand squeegee. The surface shall then be dusted with sand or crushed dust.

b) **Cracks greater than 3.0mm in width**

Before these cracks are filled a steel wire brush or router shall be used to clean them and then a compressed air jet shall be used to clean and remove any foreign or loose material in the crack until the entire crack area is clean.

When the crack and surrounding area have been thoroughly cleaned, dry sand shall be forced into the crack until it is sealed in the manner specified for cracks less than 3.0mm width.

c) **Potholes, edges and other repair areas**

Where instructed, the Contractor shall prepare areas for the repair of potholes, road edges and other repair areas by excavating off unsuitable or failed material and debris, trimming off excavated edges, cleaning and compacting the resulting surfaces and applying MC 30 or MC 70 cut-back bitumen prime coat at a rate of 0.8-1.2 litres/m<sup>2</sup>, all as directed by the Engineer. Measurement and payment shall be made under the relevant item of Bill No 15. Where the surface repair on potholes and edges are to be carried out, Asphalt Concrete Type I (0/14 gradation) shall be used. Bituminous material for repair of failures and other repair areas shall be paid for under the relevant item of Bill No 16

## **PART B - PRIME COAT**

### **1502B MATERIALS FOR PRIME COAT AND TACK COAT.**

For prime coat, the binder shall be a medium-curing cutback MC 70 unless otherwise directed by the Engineer.

The rate of spray of bituminous prime coat refers to the gross volume of the cutback bitumen, that is to say the volume of the bitumen plus diluents.

Prime coat shall be applied to gravel areas that are to receive bituminous mixes as directed by the Engineer.

The tack coat shall consist of bitumen emulsion KI-60 unless otherwise directed by the Engineer.

The rates of spray of the binder shall be as instructed by the Engineer and shall generally be within the range 0.8-1.2 litres/square metre.

### **1502C MATERIALS FOR SURFACE DRESSING**

Material for surface dressing will be pre-coated chipping class 1 and grading shall be 10/14 on Carriageway and Shoulders. The bituminous binder used for pre-coating chippings shall be MC-70 and the bituminous binder for surface dressing shall be 80/100 pen grade bitumen.

### **1511C MEASUREMENT AND PAYMENT**

#### **(a) Seal coat**

Seal coats shall be measured by the litre, for each type of bituminous binder for each seal coat, calculated as the product of the area in square metres sprayed and the rate of application in litres/square metres, corrected to 15.6 ° C

## **SECTION 16 - BITUMINOUS MIX BASES, BINDER COURSES AND WEARING COURSES**

This section covers different types of bituminous mixes for base and surface (wearing and binder courses) and is divided into the following parts: -

Part A            General

Part B            Superpave Asphalt Concrete for Shoulders

Part C            Superpave DBM for carriageway

### **PART A – GENERAL**

#### **1601A            SCOPE OF PART A**

Part A comprises all the general requirements for bituminous mixes, which apply to Part B as well.

#### **1602A            REQUIREMENTS FROM OTHER SECTIONS**

The following sections of this Specification apply to Part B of this section and shall be read in conjunction therewith:-

Section 2	Materials and Testing of Materials
Section 3	Setting Out and Tolerances
Section 6	Quarries, Borrow Pits, Stockpile and Spoil Areas
Section 15	Bituminous Surface Treatments and Surface Dressing

#### **1603A            CONSTRUCTION PLANT**

(a)            **General**

The Contractor shall submit to the Engineer in accordance with Section 1 of its Specification, full details of the construction plant he proposes to use and the procedures he proposes to adopt for carrying out the permanent Works.

The Engineer shall have access at all times to construction plant for the purposes of inspection. The Contractor shall carry out regular calibration checks in the presence of the Engineer and shall correct forthwith any faults that are found.

All construction plant used in the mixing, laying and compacting of bituminous mixes shall be of adequate rated capacity, in good working condition, and shall be acceptable to the Engineer. Obsolete or worn-out plant will not be allowed on the work.

(b) **Mixing Plant**

Bituminous materials shall be mixed in a plant complying with ASTM Designation D995 and shall be located on the Site unless otherwise agreed by the Engineer. It shall be equipped with at least three bins for the storage of heated aggregates and a separate bin for filler. All bins shall be covered to prevent the ingress of moisture.

The plant may be either the batch-mix type or the continuous-mix type and shall be capable of regulating the composition of the mixture to within the tolerances specified in Clause 1614A of this Specification.

The bitumen tank shall be capable of maintaining its contents at the specified temperature within a tolerance of 5<sup>0</sup>C and a fixed thermometer easily read from outside the tank. Any bitumen that has been heated above 180<sup>0</sup>C or has suffered carbonisation from prolonged heating shall be removed from the plant and disposed of.

(c) **Laying Plant**

Bituminous materials shall be laid by a self-propelled spreader finisher equipped with a hopper, delivery augers and a heated adjustable vibrating screed. It shall be capable of laying bituminous materials with no segregation, dragging, burning or other defects and within the specified level and surface regularity tolerance. Delivery augers shall terminate not more than 200mm from the edge plates.

(d) **Compaction Plant**

The Contractor shall provide sufficient rollers of adequate size and weight to achieve the specified compaction. Prior to commencing the laying of bituminous mixes in the permanent Works the Contractor shall carry out site trials in accordance with Section 2 of this Specification to demonstrate the adequacy of his plant and to determine the optimum method of use and sequence of operation of the rollers.

It is important to achieve as high a density as possible at the time of construction and it is expected that vibrating rollers will be required to produce the best results. However, it is essential that thorough pre-construction trials are carried out to ensure that:-

- (a) The roller is set up to have the optimum amplitude and frequency of vibration for the particular material being laid
- (b) That the roller does not cause breakdown of the aggregate particles.
- (c) That the optimum compaction temperatures are established which allow compaction without causing ripple effects or other distortions of the surfacing.

#### **1604A PREPARATION OF SURFACE**

Immediately before placing the bituminous mix in the pavement, the existing surface shall be cleaned of all material and foreign matter with mechanical brooms or by other approved methods. The debris shall be deposited well clear of the surface to be covered.

Any defect of the surface shall be made good and no bituminous mix shall be laid until the Engineer has approved the surface.

A tack coat shall be applied in accordance with Section 15 of this Specification. If the Engineer considers a tack coat is required prior to laying the bituminous mix or between layers of the bituminous mix, due solely to the

Contractor's method of working, then such tack coat shall be at the Contractor's expense.

#### **1605A DESIGN AND WORKING MIXES**

At least two months prior to commencing work using a bituminous mix, the Contractor shall, having demonstrated that he can produce aggregates meeting the grading requirements of the Specification, submit samples of each constituent of the mix to the Engineer. The contractor in the presence of the Engineer will then carry out laboratory tests in order to decide upon the proportion of each constituent of the initial design mix or mixes to be used for site trials to be carried out in accordance with Clause 1606A of this Specification.

Should the Engineer conclude from the site trials that the mix proportion or aggregate grading are to be changed, the Contractor shall submit further samples of the constituents and carry out further site trials all as directed by the Engineer.

The Engineer may instruct the alteration of the composition of the -75 micron fraction of the aggregates by the addition or substitution of mineral filler. The Engineer may also instruct the alteration of all or part of the -6.3mm fraction of the aggregates by the addition or substitution of natural sand.

The Contractor shall make the necessary adjustments to his plant to enable the revised mix to be produced.

Following laboratory and site trials the contractor jointly with the Engineer will determine the proportions of the working mix and the Contractor shall maintain this composition within the tolerances given in Clause 1614A.

Should any changes occur in the nature or source of the constituent materials, the Contractor shall advise the Engineer accordingly? The procedure set out above shall be followed in establishing the new mix design.

#### **1606A SITE TRIALS**

Full scale laying and compaction site trials shall be carried out by the Contractor on all asphalt pavement materials proposed for the Works using the construction plant and methods proposed by the Contractor for constructing the Works. The trials shall be carried out with the agreement, and in the presence of the Engineer, at a location approved by the Engineer.

The trials shall be carried out to: -

- a) Test materials, designed in the laboratory, so that a workable mix that satisfies the specification requirements can be selected.
- b) To enable the Contractor to demonstrate the suitability of his mixing and compaction equipment to provide and compact the material to the specified density and to confirm that the other specified requirements of the completed asphalt pavement layer can be achieved.

Each trial area shall be at least 100 metres long and to the full construction width and depth for the material. It may form part of the Works provided it complies with this Specification. Any areas that do not comply with this Specification shall be removed.

The Contractor shall allow in his programme for conducting site trials and for carrying out the appropriate tests on them. The trial on any pavement layer shall be undertaken at least 21 days ahead of the Contractor proposing to commence full-scale work on that layer.

The Contractor shall compact each section of trial over the range of compactive effort the Contractor is proposing and the following data shall be recorded for each level of compactive effort at each site trial: -

- i. The composition and grading of the material including the bitumen content and type and grade of bitumen used.
- ii. The moisture content of aggregate in the asphalt plant hot bins.

- iii. The temperature of the bitumen and aggregate immediately prior to entering the mixer, the temperature of the mix on discharge from the mixer and the temperature of the mix on commencement of laying, on commencement of compaction and on completion of compaction. The temperature of the mixture is to be measured in accordance with BS 598, Part 3, Appendix A.
- iv. The type, size, mass, width of roll, number of wheels, wheel load, tyre pressures, frequency of vibration and the number of passes of the compaction equipment, as appropriate for the type of roller.
- v. The target voids and other target properties of the mix together with the results of the laboratory tests on the mix.
- vi. The density and voids achieved.
- vii. The compacted thickness of the layer.
- viii. Any other relevant information as directed by the Engineer.

At least eight sets of tests shall be made by the Contractor and the Engineer on each 100 metres of trial for each level of compactive effort and provided all eight sets of results over

the range of compactive effort proposed by the Contractor meet the specified requirements for the material then the site trial shall be deemed successful. The above data recorded in the trial shall become the agreed basis on which the particular material shall be provided and processed to achieve the specified requirements.

#### **1607A MIXING OF AGGREGATES AND BITUMEN**

The bitumen shall be heated so that it can be distributed uniformly and care shall be taken not to overheat it. The temperature shall never exceed 170<sup>0</sup> C for 60/70-penetration grade bitumen.

The aggregates shall be dried and heated so that they are mixed at the following temperatures: -

125-165<sup>0</sup>C when 60/70 bitumen is used

The dried aggregates shall be combined in the mixer in the amount of each fraction instructed by the Engineer and the bitumen shall then be introduced into the mixer in the amount specified. The materials shall then be mixed until a complete and uniform coating of the aggregate is obtained.

The mixing time shall be the shortest required to obtain a uniform mix and thorough coating. The wet mixing time shall be determined by the Contractor and agreed by the Engineer for each plant and for each type of aggregate used. It shall normally not exceed 60 seconds.

#### **1608A TRANSPORTING THE MIXTURE**

The bituminous mix shall be kept free of contamination and segregation during transportation. Each load shall be covered with canvas or similar covering to protect it from the weather and dust.

## **1609A            LAYING THE MIXTURE**

Immediately after the surface has been prepared and approved, the mixture shall be spread to line and level by the laying plant without segregation and dragging.

The mixture shall be placed in widths of one traffic lane at a time, unless otherwise agreed by the Engineer. The compacted thickness of any layer shall be at least 2.5 times the maximum size of the aggregate for wearing course and at least 2 times for binder course. The minimum thickness shall be 25mm.

Only on areas where irregularities or unavoidable obstacles make the use of mechanical laying impracticable, may the mixture be spread and compacted by hand.

## **1610A            COMPACTION**

Immediately after the bituminous mixture has been spread, it shall be thoroughly and uniformly compacted by rolling.

The layer shall be rolled when the mixture is in such a condition that rolling does not cause undue displacement or shoving.

The number, weight and type of rollers furnished shall be sufficient to obtain the required compaction while the mixture is in a workable condition. The sequence of rolling operations shall be as agreed with the Engineer and proved during site trials. Initial rolling with steel tandem or three-wheeled roller shall follow the laying plant as closely as possible. The rollers shall be operated with the drive roll nearest the laying plant, at a slow and uniform speed (not exceeding 5 Km/Hr).

Rolling shall normally commence from the outer edge and proceed longitudinally parallel to the centreline, each trip overlapping one half of the roller width. On super elevated curves, rolling shall begin at the low side and progress to the high side. Where laying is carried out in lanes care must be taken to prevent water entrapment.

Intermediate rolling with a pneumatic-tyred or vibratory roller shall follow immediately. Final rolling with a steel-wheeled roller shall be used to eliminate marks from previous rolling.

To prevent adhesion of the mixture to the rollers, the wheels shall be kept lightly moistened with water.

In areas too small for the roller, a vibrating plate compactor or a hand tamper shall be used to achieve the specified compaction.

## **1611A FINISHING, JOINTS AND EDGES**

Any mixture that becomes loose and broken, mixed with dirt or foreign matter or is in any way defective, shall be removed and replaced with fresh hot mixture, which shall be compacted to conform to the surrounding area.

Spreading of the mixture shall be as continuous as possible. Transverse joints shall be formed by cutting neatly in a straight line across the previous run to expose the full depth of the course. The vertical face so formed shall be painted lightly with hot 60/70 penetration grade bitumen just before the additional mixture is placed against it.

Longitudinal joints shall be rolled directly behind the paving operation. The first lane shall be placed true to line and level and have an approximately vertical face. The mixture placed in the abutting lane shall then be tightly crowded against the face of the previously placed lane. The paver shall be positioned to spread material overlapping the joint face by 20-30mm. Before rolling, the excess mixture shall be raked off and discarded.

When the abutting lane is not placed in the same day, or the joint is destroyed by traffic, the edge of the lane shall be cut back as necessary, trimmed to line and painted lightly with hot 60/70 penetration grade bitumen just before the abutting lane is placed.

Any fresh mixture spread accidentally on the existing work at a joint shall be carefully removed by brooming it back on to uncompacted work, so as to avoid formation of irregularities at the joint. The finish at joints shall comply with the surface requirements and shall present the same uniformity of finish, texture and density as other sections of the work.

The edges of the course shall be rolled concurrently with or immediately after the longitudinal joint. In rolling the edges, roller wheels shall extend 50 to 100mm beyond the edge.

## **1612A SAMPLING AND TESTING OF BITUMINOUS MIXTURES**

The sampling of bituminous mixtures shall be carried out in accordance with AASHTO T168 (ASTM Designation D979).

## **1613A QUALITY CONTROL TESTING**

During mixing and laying of bituminous mixtures, control tests on the constituents and on the mixed material shall be carried out in accordance with Clause 1612A and Section 2 of this Specification.

If the results of any tests show that any of the constituent materials fail to comply with this Specification, the Contractor shall carry out whatever changes may be necessary to the materials or the source of supply to ensure compliance.

If the results of more than one test in ten on the mixed material show that the material fails to comply with this Specification, laying shall forthwith cease until the reason for the failure has been found and corrected. The Contractor shall remove any faulty material laid and replace it with material complying with this Specification all at his own expense.

## **1614A TOLERANCES**

Surfacing courses and base shall be constructed within the geometric tolerances specified in Section 3 of this Specification.

The Contractor shall maintain the composition of the mixture as determined from the laboratory and site trials within the following tolerances, per single test: -

Bitumen Content	0.3% (by total weight of total mix)
Passing 10mm sieve and larger sieves	6% (by total weight of dry aggregate including mineral filler)
Passing sieves between 10mm and 1.0mm sieves	4% (by total weight of dry aggregate including mineral filler)
Passing sieves between 1.0mm and 0.075mm sieve	3% (by total weight of dry aggregate including mineral filler)
Passing 0.075mm sieve	2% (by total weight of dry aggregate Including mineral filler)

The average amount of bitumen in any length of any layer, calculated as the product of the bitumen contents obtained from single tests and the weight of mixture represented by each test, shall not be less than the amount ordered.

The average amount of bitumen for each day's production calculated from the checked weights of mixes shall not be less than the amount ordered.

The average amount of bitumen in any length of any layer, calculated as the product of the bitumen contents obtained from single tests and the weight of mixture represented by each test, shall not be less than the amount ordered.

The average amount of bitumen for each day's production calculated from the checked weights of mixes shall not be less than the amount ordered.

The final average overall width of the upper surface of a bituminous mix layer measured at six equidistant points over a length of 100m shall be at least equal to the width specified. At no point shall the distance between the centreline of the road and the edge of the upper surface of a bituminous mix layer be narrower than that specified by more than 13mm.

#### **1615A            MEASUREMENT AND PAYMENT**

No separate measurement and payment shall be made for complying with the requirements of Clauses 1601A to 1614A inclusive and the Contractor shall be deemed to have allowed in his rates in Parts B and C of Section 16 of this Specification for the costs of complying with the requirements of Part A of Section 16 of this Specification

**PART B**

**ASPHALT CONCRETE FOR SURFACING - SUPERPAVE**

**1601B INTRODUCTION**

Some modifications, to the Standard Specification, which takes into account aspects of the Super pave Mix Design methods, have been made. This shall be in accordance with the procedures presented in Overseas Road Note 19, ‘‘ A guide to the design of hot mix asphalt in tropical and subtropical countries’’ and detailed in the current manuals produced by the Asphalt Institute. The contractor shall be deemed to possess a copy of these publications and shall provide at least two copies of each on site, one for the Engineer and the other for the Contractor.

**1602B MATERIALS FOR ASPHALT CONCRETE**

**(a) Penetration grade bitumen**

Bitumen shall be 60/70 penetration grade, and shall meet the requirements of Table 4.3 in ORN 19 as summarised below:

**Minimum requirements for penetration grade bitumen (ORN19 Table 4.3)**

<i>Test</i>		<i>Test method (ASTM)</i>	<i>Penetration grade</i>		
			40/50	60/70	80/100
Based on original bitumen					
Penetration at 25 <sup>0</sup> C		D 5	40-50	60-70	80-100
Softening point (°C)		D 36	49-59	46-56	42-51
Flash point (°C)	Mi	D 92	232	232	219
	n				
Solubility in trichloroethylene (%)	Mi	D 2042	99	99	99
	n				
TFOT heating for 5h at 163 °C		D1754			
a. Loss by mass (%)	Ma	-	0.5	0.5	0.8
	x				
b. Penetration (% of original)	Mi	D 5	58	54	50
	n				
c. Ductility at 25°C	Mi	D 113	-	50	75
	n				

**(b) Aggregate**

(i) In the standard specification rename Table 16B-1 as 16B-1(a)

Add the following:

The coarse aggregate shall be entirely crushed rock, from a source known to give high values of stability (> 9kN) in the Marshall test. Aggregate shall be Class 'a' meeting the requirements given in Table 16B-1b below.

**Table 16B-1b: Requirements for coarse aggregate**

Property	Test	Property	
Cleanliness	Sand equivalent: <sup>1</sup> for <4.75 mm fraction (Material passing 0.425 sieve)	>40	
	Plasticity Index <sup>2</sup>	<4	
	Linear Shrinkage	<2	
Particle shape	Flakiness Index (FI) <sup>3</sup>	<25	
Strength	Aggregate Crushing Value (ACV) <sup>4</sup>	<25	
	Aggregate Impact Value (AIV) <sup>4</sup>	<25	
	10% FACT (dry) kN <sup>4</sup>	>160	
	Los Angeles Abrasion (LAA) <sup>5</sup>	<30	
Abrasion	Aggregate Abrasion Value <sup>4</sup>	<12	
Soundness <sup>7</sup> (5 cycles, % loss)	Sodium Sulphate Soundness (SSS):	Coarse aggregate	<10
		Fine aggregate	<16
	Magnesium Sulphate Soundness (MSS):	Coarse aggregate	<15
		Fine aggregate	<20
Polishing	Polished Stone Value	>60	
Water absorption	Water Absorption <sup>6</sup>	<2	
Bitumen affinity	Immersion Mechanical test: index of retained Marshall stability <sup>8</sup>	>75	
	Static Immersion Test <sup>9</sup>	>95% coating retained	
	Retained Indirect Tensile strength <sup>10</sup>	>79% (at 7% VIM)	

- 1 AASHTO T176
- 2 British Standard 1377: Part 2
- 3 British Standard 812: Part 105
- 4 British Standard 812: Parts 110 to 114
- 5 ASTM C131 and C535
- 6 British Standard 812: Part 2
- 7 AASHTO T104
- 8 D White oak (1990) (Shell Bitumen Handbook)
- 9 AASHTO T182
- 10 AASHTO T283

Unless otherwise instructed by the Engineer aggregates shall satisfy the following Superpave aggregate consensus properties which requirements are presented in Table 16B-1(c):

- Coarse Aggregate Angularity (CAA) – ASTM D 5821
- Fine Aggregate Angularity (FAA) – AASHTO T 304
- Flat and elongated particles – ASTM D 4791
- Sand equivalent – AASHTO T 176

**Table 16B-1(c) Superpave aggregate consensus property requirements**

Cumulative Equivalent Standard Axles (CESA) <sup>1</sup> in Million	Fractured faces, Coarse Aggregate, Percent Minimum		Uncompacted Void Content of Fine Aggregate, Percent Minimum		Sand Equivalent, Percent Minimum	Flat and Elongated <sup>3</sup> , Percent Maximum
	Depth from surface		Depth from surface			
	≤100mm	>100mm	≤100mm	>100mm		
≥ 30	100/100	100/100	45	45	50	10

<sup>1</sup>The anticipated project traffic level expected over a 20 year design period

<sup>2</sup>85/80 denotes that 85 percent of the coarse aggregate has one fractured face and 80 percent has two or more fractured faces

<sup>3</sup>Criterion based upon a 5:1 maximum to minimum ratio

The grading mixture of coarse and fine aggregate shall meet the requirements given in Table 16B-1(d) for a 19mm and 12.5mm nominal maximum size aggregate.

**A gradation of 19mm and 12.5mm nominal maximum size aggregate shall be used for the works**

**Table 16B-1(d) Superpave aggregate grading control point**

Nominal Maximum Size (mm)  (Note 1 below)	Sieve size  (mm)	Control point  (%passing)	
		Minimum	Maximum
19.0	25	100	-
	19	90	100
	12.5	-	90
	2.36	23	49
	0.075	2	8

*Note (1) - The definition of Nominal Maximum Size of aggregate is one sieve larger than the first sieve to retain more than ten per cent of the aggregate. It is also recommended that where possible the largest particle size should not be more than 25 mm so that the requirements of the Marshall test can be complied with.*

**1604B REQUIREMENTS FOR ASPHALT CONCRETE**

The mix design should be carried out using the Superpave test procedures.

**Superpave - Shoulders**

The mix design, when compacted in accordance with AASHTO T 312 (Preparing and determining the density of Hot Mix Asphalt (HMA) specimens by means of the Superpave gyratory compactor) shall meet the relative density, voids in the mineral aggregate (VMA), Voids filled with Asphalt (VFA) and dust to binder ratio requirements specified in Table 16-B2(b).

The initial, design and maximum number of gyrations are specified in AASHTO R 35, Superpave volumetric design for Hot Mix Asphalt (HMA).

Cumulative Equivalent Standard Axles (CESA) <sup>1</sup> in Million	Required Relative Density, Percent of theoretical maximum specific gravity			Voids in the Mineral Aggregate (VMA), Percent Minimum	Voids Filled with Asphalt (VFA) Range, Percent	Dust-to-Binder Ratio Range
	N initial	N design	N max	Nominal maximum size Aggregate (mm)		
				19.0		
>10	≤89.0	96.0	≤98.0		65-75	0.6-1.2

<sup>1</sup>The anticipated project traffic level expected over a 20 year design period

## **1605B MIXING AND LAYING ASPHALT CONCRETE**

Add the following:

The temperature of the bitumen and aggregates when mixed should be determined using both Penetration Index (PI) and softening point of the bitumen on the bitumen tests data chart (BTDC). The temperature of the bitumen and aggregates when mixed shall be 110+/-3°C above the softening point (Ring and Ball) of the bitumen.

Compaction shall commence as soon as the mix can support the roller without undue displacement of material and completed before the temperature of the mix falls below 90°C.

The mixing and placing of asphalt concrete must be carried out only under favorable weather conditions. Mixing and placing of asphalt concrete will not be allowed if the moisture content of aggregate affects the uniformity of temperature, or if free water is present on the working surface. Mixing shall not be allowed to take place more than two hours before placing begins unless provision had been made for storing. Storage of mixed materials will only be permitted in insulated hot mix bins. In any case, storage will not be permitted for a period longer than 12 hours after mixing, unless otherwise approved by the Engineer.

The minimum thickness of the compacted layer shall be 35mm when 12.5mm nominal maximum size aggregate is used (on the road shoulders).

## **1606B COMPACTION**

Rolling shall be continued until compaction of the completed layer attains a minimum mean value of 95% of refusal density (no value less than 93%) and until the voids measured in the compacted layer are within the specified range as appropriate.

## **1607B MEASUREMENT AND PAYMENT**

a) Item : Asphalt Concrete

Unit: m<sup>3</sup> of Asphalt Concrete Used

Asphalt concrete shall be measured by the cubic metre compacted on the road calculated as the product of the length instructed to be laid and the compacted cross-sectional area shown on the Drawings or instructed by the Engineer.

The rate for asphalt concrete shall include for the cost of providing, transporting, laying and compacting the mix with the nominal binder content and complying with the requirements of Parts A and B of Section 16 of this Specification.



## **SECTION 17 - CONCRETE WORKS**

### **1703 MATERIALS FOR CONCRETE**

This work shall consist of placing selected approved material of 250mm minimum diameter on the foundation put after excavation to receive levelling concrete in accordance with these specifications and in conformity with the lines, grades and cross sections shown on the Drawings as directed by the Engineer.

#### **(a) Materials**

Selected rock: The selected rock builders to be placed for this work shall be hard, sound, durable quarry stones as approved by the Engineer. Samples of the stone to be used shall be submitted to and approved by the Engineer before any stone is placed.

The maximum size of the stone boulders shall be 300mm.

#### **(b) Construction Method**

After completion of the structural excavation the surface of the loose soil shall be levelled and compacted. Then the stone of the above sizes shall be placed in one layer of 250mm over the compacted bed where the bottom slab will rest. Coarse sand shall be spread to fill up the voids in the stone boulders, and compaction with vibratory compactors should be performed to make this layer dense whereon a concrete of levelling course shall be placed.

#### **(c) Measurement and payment**

Measurement for the bedding materials shall be made in cubic metres for the completed and accepted work, measured from the dimension shown on the Drawings, unless otherwise directed by the Engineer.

Payment for the bedding Materials for Levelling Concrete Works shall be full compensation for furnishing and placing all materials, all labour equipment, tools and all other items necessary for proper completion of the work in accordance with the Drawings and specifications and as directed by the Engineer.

### **1703(A) LEVELLING CONCRETE (CLASS 15/20) FOR BOTTOM SLAB INCLUSIVE OF COST OF FORM WORKS**

This work shall consist of placing and levelling lean concrete class 15/20 over the prepared bed of stone boulders in the foundation for bottom slab and wingwalls in accordance with these specifications and which

conformity with the lines, grades, thickness and typical cross-sections shown on the drawings unless otherwise directed by the Engineer.

(a) **Materials for Levelling Concrete**

Requirement for the concrete class 15/20 is specified as follows:-

Design compressive strength (28) days : 15N/mm<sup>2</sup>

Maximum size of coarse aggregate : 20mm

Maximum cement content : 300 kg/m<sup>3</sup>.

Maximum water/cement ration of 50% with slump of 80mm.

(b) **Construction Method**

The bed of stone boulders upon which the levelling concrete will be placed shall be smooth, compacted and true to the grades and cross-section shall be set to the required lines and grades.

**2.6 (c) Measurement and payment**

Measurement for levelling concrete (class 15/20) shall be made in cubic metres completed and accepted levelling concrete work measured in place which is done in accordance with the Drawings and the Specifications.

Payment for this work shall be the full compensation for furnishing and placing all materials, labour, equipment and tools, and other incidentals to Specifications and as directed by the Engineer.

Pay item No. 17/02 Levelling Concrete Works (Class 15/20) for Box Culvert and wingwalls inclusive of Cost of Form works.

**1703 (C) FORMWORK FOR CULVERT WALLS**

This work shall consist of all temporary moulds for forming the concrete for culvert walls and slabs together with all temporary construction required for their support. Unless otherwise directed by the Engineer all formworks shall be removed on completion of the walls and slabs.

(a) **Materials**

Forms shall be made of wood or metal and shall conform to the shape, lines and dimensions shown on the Drawings.

All timber shall be free from holes, loose material, knots, cracks, splits and warps or other defects affecting the strength or appearance of the finished structure.

Release Agents – Release agents shall be either neat oils containing a surface activating agent, cream emulsions, or chemical agents to be approved by the Engineer.

**(b) Construction Method**

**(i) Formworks**

Formworks shall be designed to carry the maximum loads that may be imposed, and so be rigidly constructed as to prevent deformation due to load, drying and wetting, vibration and other causes. After forms have been set in correct location, they shall be inspected and approved by the Engineer before the concrete is placed.

If requested, the contractor shall submit to the Engineer working drawings of the forms and also, if requested, calculations to certify the rigidity of the forms.

**1703(D) CONCRETE WORKS (CLASS 20/20)**

This work shall consist of furnishing, mixing, delivering and placing of the concrete for the construction of culvert walls and slabs, in accordance with these Specifications and in conformity with the requirements shown on the Drawings.

Concrete class 20/20 shall be used as directed by the Engineer.

**(a) Concrete Materials**

(i) Cement: Cement shall be of Portland type and shall conform to the requirements of BS 12 or equivalent.

The contractor shall select only one type or brand of cement or others. Changing of type or brand of cement will not be permitted without a new mix design approved by the Engineer. All cement is subject to the Engineer's approval, however, approval of cement by the Engineer shall not relieve the Contractor of the responsibility to furnish concrete of the specified compressive strength.

Conveyance of cement by jute bags shall not be permitted. Storage in the Contractor's silo or storehouse shall not exceed more than two (2) months, and age of cement after manufacture at mill shall not exceed more than four (4) months. The Contractor shall submit to the Engineer for his approval the result of quality certificate prepared by the manufacturer.

Whenever it is found out that cement have been stored too long, moist, or caked, the cement shall be rejected and removed from the project.

**(b) Aggregates**

Fine and coarse aggregates must be clean, hard, strong and durable, and free from absorbed chemicals, clay coating, or materials in amounts that could affect hydration, bonding, strength and durability of concrete.

Grading of aggregates shall conform to the following requirements:

**(i) Grading of Fine Aggregates**

Sieve Size	Percentage by Weight Passing
10 mm	100
5 mm	89-100
2.5 mm	60-100
1.2 mm	30-100
0.6 mm	15- 54
0.3 mm	5- 40
0.15 mm	0 - 15

**(ii) Grading of Coarse Aggregates**

Size of Coarse Aggregate	Amounts finer than each standard sieve percentage by weight							
	40	30	25	20	15	10	5	2.5
	100	-	-	90-100	-	30-69	0-10	
	-							

Other requirements for aggregates are as follows:

**(iii) Fine Aggregates**

Fitness Modulus, AASHTO M-6	: 2.3 – 3.1
Sodium Sulphate Soundness, AASHTO T104	: Max. 10% loss
Content of Friable Particles AASHTO 112	: Max 1% by weight
Sand Equivalent, AASHTO T176	: Min. 75

**(iv) Coarse Aggregate**

Abrasion, AASGTO T96	: Max. 405 loss
Soft Fragment and shale, AASHTO M80	: Max. 5% by weight
Thin and elongated Pieces, AASHTO M80	: Max. 15%

**(v) Water**

All sources of water to be used with cement shall be approved by the Engineer. Water shall be free from injurious quantities of oil, alkali, vegetable matter and salt as determined by the Engineer.

**(vi) Admixture**

Only admixture, which have been tested and approved in the site laboratory through trial mixing for design proportion shall be used.

Before selection of admixture, the Contractor shall submit to the Engineer the specific information or guarantees prepared by the admixture supplier.

The contractor shall not exclude the admixture from concrete proportions.

**Concrete class 20/20**

Concrete class 20/20 shall be used as directed by the Engineer. The requirements of Concrete class 20/20 are provided as follows unless otherwise the Engineer will designate any alteration.

Design compressive strength (28 days) : 20N/mm<sup>2</sup>  
Maximum size of coarse aggregates : 20mm  
Maximum water/cement ratio of 45% with slump of 80mm

(d) **Proportioning Concrete**

The Contractor shall consult with the Engineer as to mix proportions at least thirty (30) days prior to beginning the concrete work. The actual mix proportions of cement, aggregates, water and admixture shall be determined by the Contractor under supervision of the Engineer in the site laboratory.

The Contractor shall prepare the design proportions which has 120% of the strength requirement specified for the designated class of concrete.

No class of concrete shall be prepared or placed until its job-mix proportions have been approved by the Engineer.

(e) **Concrete Work**

I. BATCHING

Batching shall be done by weight with accuracy of:

Cement : ½ percent  
Aggregate : ½ percent  
Water and Admixture : 1 percent.

II. EQUIPMENT SHOULD BE CAPABLE OF MEASURING QUANTITIES WITHIN THESE TOLERANCES FOR THE SMARTEST BATCH REGULARLY USED, AS WELL AS FOR LARGER BATCHES.

The accuracy of batching equipment should be checked every month in the presence of the Engineer and adjusted when necessary.

iii. Mixing and delivery

Slump of mixed concrete shall be checked and approved at an accuracy of +25mm against designated slump in these specifications.

iv. Concrete in hot weather

No concrete shall be placed when the ambient air temperature is expected to exceed thirty three degrees celsius (33<sup>0</sup>c) during placement operations).

v. Concreting at night

No concrete shall be mixed, placed or finished when natural light is insufficient, unless an adequate approved artificial lighting system is operated, such night work is subject to approval by the engineer.

vi. Placing

In preparation of the placing of concrete, the interior space of forms shall be cleaned and approved by the engineer prior to placing concrete. All temporary members except tie bars to support forms shall be removed entirely from the forms and not buried in the concrete. The use of open and vertical chute shall not be permitted unless otherwise directed by the engineer.

The Contractor shall provide a sufficient number of vibrators to properly compact each batch immediately after it is placed in the forms.

**(f) Measurement and Payment**

Measurements for the Concrete Works Class 20/20 of culvert walls and slabs shall be made in cubic metres for the walls and slabs actually constructed, measured from their dimensions shown on the Drawings. Payment for the Concrete Works (Class 20/20) of culvert walls and slabs shall be the full compensation for furnishing all materials of the concrete mixing, delivering, placing and curing the concrete, equipment and tools, labour and other incidental necessary for the completion of the work in accordance with the Drawings and these Specifications and as directed by the Engineer.

## **SECTION 20 - ROAD FURNITURE**

### **2001 ROAD RESERVE BOUNDARY POSTS**

Road reserve boundary posts shall be provided as directed by the Engineer as per the attached drawings and in compliance with Standard Specification clause 2001.

The road shall be referenced at an interval of 250m or as instructed by the Engineer and at right angles to the center line.

The concrete mix used for reference markers shall be of class 20/20.

The monument shall be IPC (Iron Pin in Concrete) of 4 No. T10mm having a total length of 1.65m with 1.35m and 0.45m above and below the ground level respectively.

The part above the ground level shall be square top of width 300mm and height of 1.35m. The part below the ground level shall be conical in shape with the top base diameter of 300mm and base diameter of 600mm and depth 0.45m.

The monument shall be precast as one piece. The inscription KeNHA shall be done on one side of each reference marker.

After erecting the monument, the bottom part shall be concreted with concrete of class 15/20. (and there after curing done for 7 days.

### **2003 EDGE MARKER POST**

Edge marker post shall be provided as directed by the Engineer and in compliance with Standard Specification clause clause 2003

### **2004 PERMANENT ROAD SIGNS**

Permanent Road Signs shall be provided as directed by the Engineer and in compliance with the requirements of the "Manual for Traffic Signs in Kenya" Part II and standard Specification clause 2004.

### **2004B EXISTING ROAD SIGNS**

Where directed by the Engineer, the Contractor shall take down road signs including all posts, nuts, bolts and fittings, and remove and dispose of the concrete foundation and backfill the post holes. The signs shall be stored as directed by the Engineer.

Measurement and payment for taking down road signs shall be made by the number of signs of any type and size taken down, cleaned and stored as directed.

## **2005 ROAD MARKING**

Paint for road marking shall be internally reflectorized hot applied thermoplastic material in accordance with Clause 219 of the Standard Specification.

The rates inserted in the Bills of Quantities for road marking shall include for prior application of approved tack coat.

### **2005A RAISED PAVEMENT MARKERS – ROAD STUDS**

#### **MATERIAL**

Road studs are moulded of acrylonitrile butadiene styrene (ABS) conforming to ASTM Specification D1788 – 68, class 5-2-2 shell filled with inert, thermosetting compound and filler. The lens portion of the marker of the marker is of optical menthlymethacrylic.

#### **CONSTRUCTION**

The road studs shall be constructed of high impact ABS containing a multi-biconvex glass lens reflector system. It shall be of monolithic construction, and not less than 98.5. m<sup>2</sup>. The height of the marker shall not exceed 17mm and the underside shall contain a non-honeycomb base (flat).

#### **REQUIREMENTS**

The markers shall conform to the following requirements

##### **Colour**

Shall be white, yellow or red as specified and the Retro – reflectance values should conform to the testing procedures of ASTME 809.

##### **Impact Resistance**

The market shall not crack or break when tested using a 1000-gram weight from a height of 1 metre. (ASTM D 2444) or BS 3900 Part E3.

##### **Resistance to Water Penetration**

Shall not have water penetration behind the lens after submerged in a water bath at 70 + 50 °F for 10 minutes. And it should still meet the reflectance Requirement. BS 998.

### **Heat Resistance**

Shall comply with the initial brightness as per BS 873 Part IV of 1978

### **Night Visibility**

The marker shall be bright as per BS 873 Part IV of 1978

### **Compression Resistance**

There shall be no cracking sound at a pressure lower than 25 tones as per BS 873 Part IV of 1978.

### **Corrosion Resistance**

After immersing a sample of Road stud in a solution containing 30g/l of sodium chloride for 30 days, there shall not be any signs of corrosion -(BS998).

**NOTE:** These markers are intended for application directly to pavement surfaces and are compatible with raised pavement markers. These adhesives should be of high quality and tested for conformance to customer requirements.

### **ADHESIVES**

They shall be of Resin Type–Epoxy of 2 different components part 1 and 2 i.e Adhesive and Reactor without any volatile solvents in both.

Pot life:	not less than 20 minutes at 20 °C
Rotational cure time:	between 20 and 30 minutes at 20 °C
Hard cure:	Between 40 and 60 minutes at 20 °C

### **APPLICATION INSTRUCTION**

#### **Preparation of Pavements**

Make sure that the road surface is absolutely dry and free of oil and grease.

### **Mixing of Adhesive**

Pour component B into the container of component A. Stir mixture by hand with a wooden or metal stick until uniform Grey Tint without a strike is obtained.

### **Installation**

Pour the mixture on to the underside of the road stud. Then place the road stud firmly on the road surface. Adhesive should stand out for about 5mm to 10 mm over the edges of the stud.

### **Protection from the Traffic**

Protect studs from traffic for 2 hours until the adhesive has properly hardened. Try by touching the adhesive.

### **NUMBER OF STUDS NEEDED FOR LABORATORY TESTS.**

In order to approve a particular type of road stud, 4 sample road studs of each colour shall be submitted.

## **2006 GUARDRAILS**

Contrary to the Standard Specification, guardrail posts shall be concrete 200 mm diameter set vertically at least 1.2m into the shoulder as directed by the Engineer. Spacer blocks shall also be made of concrete.

Beams for guardrails shall be "Armco Flexbeam" or similar obtained from a manufacturer approved by the Engineer.

## **2007 KERBS**

### a) **Vertical Joints**

Vertical joints between adjacent Kerbs shall not be greater than 5 mm in width and shall be filled with a mortar consisting of 1:3 cement: sand by volume.

### b) **Transition between flush and raised kerbs**

The transition between flush and raised kerbs (e.g. at bus bays) shall be termed as ramped kerbs. The transition between flush and raised kerbs shall occur within a length of 2.0 m.

## **2008 EDGE MARKER POSTS**

Edge marker posts shall be provided as directed by the Engineer and in compliance with Standard Specification clause 2008.

## **2009 RUMBLE STRIPS**

Where directed by the Engineer, the Contractor shall provide, place, trim, shape and compact to line and level asphalt concrete rumble strips on the finished shoulders. This shall be done to the satisfaction of the Engineer

## **2010 BOLLARDS**

Where directed by the Engineer, the Contractor shall provide, and install 150mm diameter steel encased bollards. The Bollards shall be concreted 300mm into the ground and 900mm above the ground, they shall be painted and marked with two strips of retro reflective yellow tape around the post. Concrete shall be class 15/20.

## **2011 MEASUREMENT AND PAYMENT**

### **Road reserve boundary posts**

Road reserve boundary posts shall be measured by the number erected

### **Permanent road signs**

Permanent road signs shall be measured by the number of each particular size erected.

### **Road marking**

Road markings in yellow or white material shall be measured in square metres calculated as the plan area painted.

### **Road Studs**

Road studs shall be measured by the number of each particular size erected.

## **Guardrail**

Guardrail shall be measured by the metre as the length of the guardrail constructed.

## **Kerbs**

Kerbs shall be measured by the metre as the length of kerb constructed

## **SECTION 22-DAYWORKS**

### **2202 MEASUREMENTS AND PAYMENT**

#### **(a) Plant**

Where items of major plant listed in the schedule of Dayworks are specified by type (e.g. Concrete mixer etc.) the power rating if such items of plant are provided by the Contractor shall not be lower than the power ratings of such plant manufactured within the last two years prior to the date of BID. Any item of major plant employed upon Dayworks that has a power rating lower than specified above shall be paid for at rates lower than those in the schedule of Dayworks. The reduction in the rate payable shall be in proportion to the reduction in power rating below that specified above.

## **SECTION 23: CONCRETE PAVING BLOCKS**

This works shall consist of providing, laying and fixing of concrete paving blocks and concrete paving slabs on a sand base on the driveway and walkways and other areas as directed by the Engineer.

### **a. Concrete Paving Blocks**

The paving blocks shall be of type S of any shape fitting within a 295 mm square coordinating space and a work size thickness of at least 30 mm. The blocks shall conform to the requirements of BS 6717:Pt. 1:1986 or Kenya standard equivalent.

The laying shall be broken at intervals of 50 m by concrete ribs of class 25 concrete.

The blocks shall be laid on a 40 mm minimum sand base whose specifications are as in section (b) of this specification.

### **b. Sand For Sand Base**

Sand used as bedding for paving blocks and slabs shall be natural sand either pit or river sand. The grading shall conform and be parallel as much as possible to KS02 – 95 Parts 1 & 2: 1984 for zones 1, 2 or 3. The other requirements shall be as specified in section 1703 (c) of Standard Specifications.

**c. Measurement and Payment**

Payment for paving blocks and paving slabs shall be by square metre laid. The rate quoted would include the cost of haulage to site of the blocks, slabs and sand, as no extra payment shall be made for haulage

**SECTION VIII - DRAWINGS**  
**CONCRETE SCOUR CHECKS**

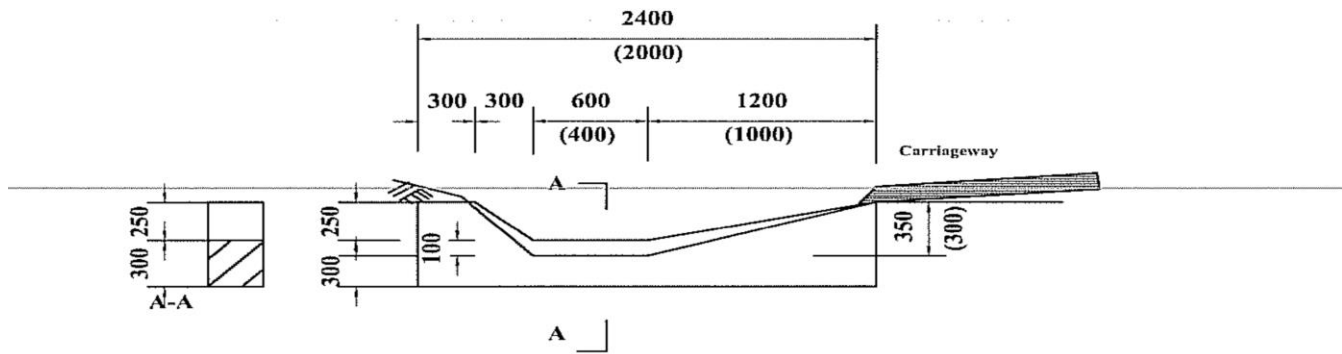

**SECTION OF CONCRETE SCOUR CHECK**

**NOTE**  
**1. Dimensions in mm**

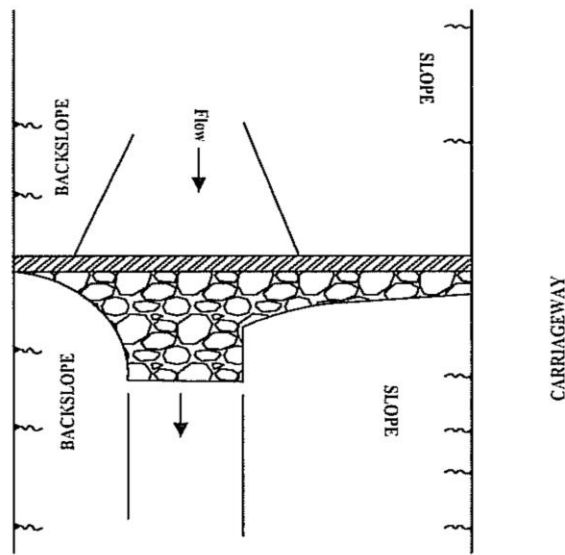

**PLAN OF DRAIN WITH SCOUR CHECK**

Cross-Section	Sizes in mm			Excav (m3)	Concrete (m3)	Apron stone pitching (m3)
	Length	Width	Depth			
A	2400	100	550	0.13	0.15	0.18
B	2000	100	500	0.10	0.09	0.14



# ROAD RESERVE BOUNDARY POSTS

## ROAD RESERVE EDGE MARKER POST

Precast Concrete Class 25/20

Dimensions in millimetres

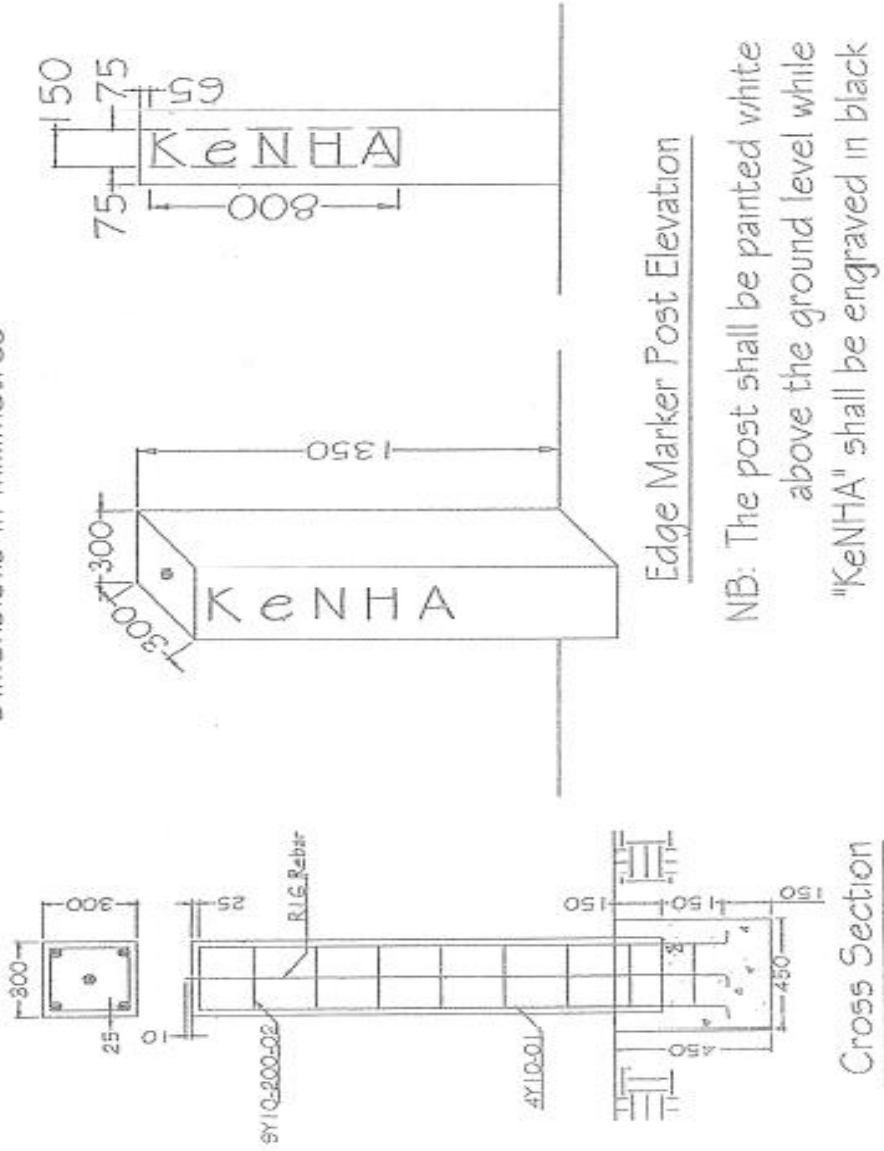

Edge Marker Post Elevation

NB: The post shall be painted white above the ground level while "KeNHA" shall be engraved in black

Cross Section



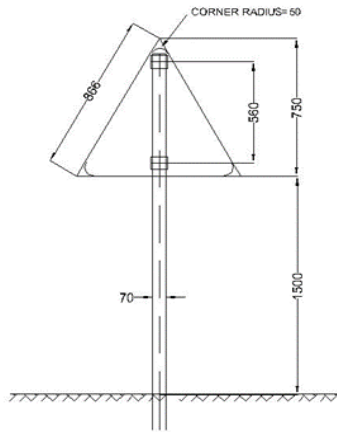

WARNING SIGN

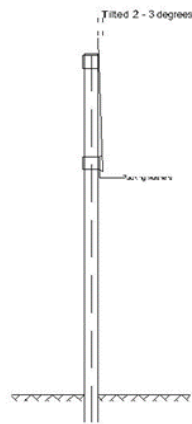

TYPICAL SIDE ELEVATION

SHAPE	CONDITION	STIFFENING
	$W > 800$	15 EDGE FLANGE OR 15*15*5 ANGLE FINISHED TO EDGES

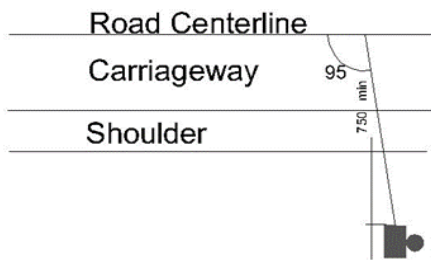

TYPICAL SIGN LOCATION PLAN

SCALE 1:20

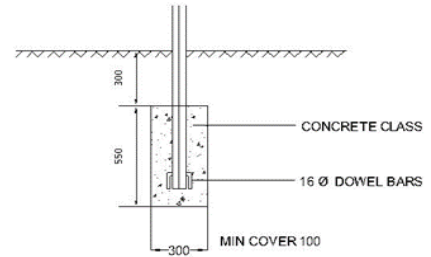

FOUNDATION DETAILS

SCALE 1:20

## WARNING SIGN DETAILS

---

**PART 3 – CONDITIONS OF CONTRACT AND CONTRACT FORMS**

---

**SECTION IX            CONDITIONS OF CONTRACT, PART I -GENERAL CONDITIONS**

## **SECTION VIII CONDITIONS OF CONTRACT PART I: GENERAL CONDITIONS OF CONTRACT**

The Conditions of Contract Part 1 – General Conditions shall be those forming Part 1 of the Conditions of Contract for works of Civil engineering construction Fourth Edition 1987, reprinted in 1992 with further amendments, prepared by the Federation Internationale des Ingenieurs Conseils (FIDIC)

Copies of the FIDIC Conditions of Contract can be obtained from:

FIDIC Secretariat

P.O. Box 86

1000 Lausanne 12

**Switzerland**

Fax: 41 21 653 5432

Telephone: 41 21 653 5003

**SECTION X CONDITIONS OF CONTRACT, PART II -CONDITIONS OF PARTICULAR APPLICATION**

**SECTION IX:           CONDITIONS OF CONTRACT PART II: (CONDITIONS OF PARTICULAR APPLICATION)**

The following Conditions of Particular Application shall supplement the General Conditions of Contract. Whenever there is a conflict, the provisions herein shall prevail over those in the General Conditions of Contract. The Particular Condition is preceded by the corresponding clause number of the General Conditions to which it relates.

## **CONTENTS**

<b>SUBCLAUSE 1.1 – DEFINITIONS</b>	<b>216</b>
<b>SUBCLAUSE 2.1 - ENGINEER’S DUTIES AND AUTHORITY.</b>	<b>216</b>
<b>SUBCLAUSE 5.1 - LANGUAGE AND LAW</b>	<b>217</b>
<b>SUBCLAUSE 5.2 – PRIORITY OF CONTRACT DOCUMENTS</b>	<b>217</b>
<b>SUBCLAUSE 10.1 - PERFORMANCE SECURITY</b>	<b>217</b>
<b>SUBCLAUSE 10.2 - VALIDITY OF PERFORMANCE SECURITY</b>	<b>217</b>
<b>SUB CLAUSE 10. 3 - CLAIMS UNDER PERFORMANCE SECURITY</b>	<b>218</b>
<b>‘SUBCLAUSE 10. 4 - COST OF PERFORMANCE SECURITY</b>	<b>218</b>
<b>SUB CLAUSE 11. 1 - INSPECTION OF SITE</b>	<b>218</b>
<b>SUBCLAUSE 14.1 PROGRAM TO BE SUBMITTED</b>	<b>219</b>
<b>SUBCLAUSE 14.2- REVISED PROGRAMME</b>	<b>220</b>
<b>SUBCLAUSE 14.3- CASHFLOW ESTIMATE</b>	<b>220</b>
<b>SUBCLAUSE 15.1- CONTRACTOR’S SUPERINTENDENCE</b>	<b>220</b>
<b>‘SUBCLAUSE 15.2- LANGUAGE ABILITY AND QUALIFICATIONS OF CONTRACTOR’S AUTHORIZED AGENT</b>	<b>220</b>
<b>SUBCLAUSE 16.2- ENGINEER AT LIBERTY TO OBJECT</b>	<b>221</b>
<b>‘SUBCLAUSE 16.3- QUALIFICATION AND LANGUAGE ABILITY OF SUPERINTENDING STAFF</b>	<b>221</b>
<b>SUBCLAUSE 16.4 – EMPLOYMENT OF LOCAL PERSONNEL</b>	<b>221</b>
<b>SUBCLAUSE 19.1- SAFETY, SECURITY AND PROTECTION OF THE ENVIRONMENT</b>	<b>221</b>
<b>SUBCLAUSE 20.4 - EMPLOYERS RISKS</b>	<b>222</b>
<b>SUBCLAUSE 21.1 - INSURANCE OF WORKS AND CONTRACTOR ‘S EQUIPMENT</b>	<b>223</b>
<b>SUBCLAUSE 21.2 – SCOPE OF COVER</b>	<b>223</b>
<b>SUB CLAUSE 21.4 - EXCLUSIONS</b>	<b>223</b>
<b>SUBCLAUSE 23.2 – MINIMUM AMOUNT OF INSURANCE</b>	<b>223</b>
<b>SUBCLAUSE 25.1 – EVIDENCE AND TERMS</b>	<b>224</b>
<b>SUBCLAUSE 25.5 – INSURANCE NOTICES</b>	<b>224</b>
<b>SUBCLAUSE 25.6 – NOTIFICATION TO INSURERS</b>	<b>224</b>
<b>SUBCLAUSE 28.2 – ROYALTIES</b>	<b>224</b>
<b>SUBCLAUSE 29.1 – INTERFERENCE WITH TRAFFIC</b>	<b>224</b>
<b>SUBCLAUSE 29.2 – REINSTATEMENT AND COMPENSATION FOR DAMAGES TO PERSONS AND PROPERTY</b>	<b>225</b>
<b>SUBCLAUSE 34.2 – CONDITIONS OF EMPLOYMENT OF LABOUR</b>	<b>225</b>
<b>SUBCLAUSE 34.3 – FAIR WAGES</b>	<b>225</b>
<b>SUBCLAUSE 34.4 – BREACH OF FAIR WAGES CLAUSE</b>	<b>226</b>
<b>SUBCLAUSE 34.5 – RECRUITMENT OF UNSKILLED LABOUR</b>	<b>226</b>
<b>SUBCLAUSE 34.6 – COMPENSATION FOR INJURY</b>	<b>226</b>
<b>SUBCLAUSE 34.7 – LABOUR STANDARDS</b>	<b>226</b>
<b>SUBCLAUSE 35.2 – RECORDS OF SAFETY AND HEALTH</b>	<b>227</b>
<b>SUBCLAUSE 35.3 – REPORTING OF ACCIDENTS</b>	<b>227</b>
<b>SUBCLAUSE 41.1 – COMMENCEMENT OF WORKS</b>	<b>227</b>
<b>SUBCLAUSE 43.1 – TIME FOR COMPLETION</b>	<b>227</b>
<b>SUBCLAUSE 44.1 – EXTENSION OF TIME FOR COMPLETION</b>	<b>Error! Bookmark not defined.</b>
<b>SUBCLAUSE 45.1 – RESTRICTION ON WORKING HOURS</b>	<b>Error! Bookmark not defined.</b>
<b>SUBCLAUSE 47.2 – REDUCTION OF LIQUIDATED DAMAGES</b>	<b>Error! Bookmark not defined.</b>
<b>SUBCLAUSE 48.3 – Substantial Completion of Parts</b>	<b>Error! Bookmark not defined.</b>
<b>SUBCLAUSE 49.1 – DEFECTS LIABILITY PERIOD</b>	<b>Error! Bookmark not defined.</b>
<b>SUBCLAUSE 49.2 – COMPLETION OF OUTSTANDING WORK AND REMEDYING DEFECTS</b>	<b>Error! Bookmark not defined.</b>
<b>SUBCLAUSE 51.1 – VARIATIONS</b>	<b>Error! Bookmark not defined.</b>
<b>SUBCLAUSE 52.1 – VALUATION AND VARIATIONS</b>	<b>Error! Bookmark not defined.</b>

**SUBCLAUSE 52.4 – VARIATIONS EXCEEDING 25 PERCENT** Error! Bookmark not defined.  
**SUBCLAUSE 52.4 – DAYWORKS** Error! Bookmark not defined.  
**SUBCLAUSE 54.1 – CONTRACTOR’S EQUIPMENT, TEMPORARY WORKS AND MATERIALS**  
Error! Bookmark not defined.  
**SUBCLAUSE 55.2 – OMMISIONS OF QUANTITIES** Error! Bookmark not defined.  
**SUBCLAUSE 58.4 – PROVISIONAL ITEMS** Error! Bookmark not defined.  
**SUBCLAUSE 60.1 – MONTHLY STATEMENT** Error! Bookmark not defined.  
**SUBCLAUSE 60.2 INTERIM PAYMENT CERTIFICATE** Error! Bookmark not defined.  
**SUBCLAUSE 60.3 – PAYMENT OF RETENTION MONEY** Error! Bookmark not defined.  
**SUBCLAUSE 60.4– CORRECTION OF CERTIFICATES** Error! Bookmark not defined.  
**SUBCLAUSE 60.5– STATEMENT AT COMPLETION** Error! Bookmark not defined.  
**SUBCLAUSE 60.6 – FINAL STATEMENT** Error! Bookmark not defined.  
**SUBCLAUSE 60.7– DISCHARGE** Error! Bookmark not defined.  
**SUBCLAUSE 60.8 – FINAL PAYMENT CERTIFICATE** Error! Bookmark not defined.  
**SUBCLAUSE 60.9– CESSATION OF EMPLOYERS LIABILITY** Error! Bookmark not defined.  
**SUBCLAUSE 60.10 – TIME FOR PAYMENT** Error! Bookmark not defined.  
**SUBCLAUSE 60.11 – CURRENCY OF PAYMENT** Error! Bookmark not defined.  
**SUBCLAUSE 60.12 – ADVANCE PAYMENT** Error! Bookmark not defined.  
**SUBCLAUSE 60.13 MATERIALS FOR PERMANENT WORKS** Error! Bookmark not defined.  
**SUBCLAUSE 63.1** Error! Bookmark not defined.  
**SUBCLAUSE 67.1 – ENGINEER’S DECISION** Error! Bookmark not defined.  
**SUBCLAUSE 67.2 – AMICABLE SETTLEMENT** Error! Bookmark not defined.  
**SUBCLAUSE 67.3 – ADJUDICATION** Error! Bookmark not defined.  
**SUBCIAUSE 67.3 – ARBITRATION** Error! Bookmark not defined.  
**SUBCLAUSE 68.2 – NOTICES TO EMPLOYER AND ENGINEER** Error! Bookmark not defined.  
**CLAUSE 69 – DEFAULT OF EMPLOYER** Error! Bookmark not defined.  
**CLAUSE 70 – CHANGES IN COST AND LEGISLATION** Error! Bookmark not defined.  
**CLAUSE 72 – RATES OF EXCHANGE COST** Error! Bookmark not defined.  
**CLAUSE 73 – BRIBERY AND COLLUSION** Error! Bookmark not defined.  
**CLAUSE 74 – CONTRACT CONFIDENTIAL 241**

## **CONDITIONS OF CONTRACT PART II (CONDITIONS OF PARTICULAR APPLICATION)**

### **SUBCLAUSE 1.1 – DEFINITIONS**

Amend this sub-clause as follows:

- (i) The “Employer” is the Kenya National Highways Authority, represented by the Director General - Kenya National Highways Authority.
  - (iv) The “Engineer” is the Director Maintenance - Kenya National Highways Authority.
  - (v) The “Engineer Representative” is the Deputy Director Regional Network Coordination - West
- .
- (b) (i) Insert in line 2 after the Bills of Quantities”, the following, “the rates entered by the Contractor (whether or not such rate be employed in computation of the Contract Price),”

Amend subparagraph (b) (v) of Sub-Clause 1.1 by adding the following words at the end:

The word “Tender” is synonymous with “bid” and the word “Appendix to Tender” with “Appendix to Bid” and the word “Tender documents” with “bidding documents”.

Add the following at the end of this sub-clause:

- (h) (i) “Materials” means materials and other things intended to form or forming part of the Permanent Works.

### **SUBCLAUSE 2.1 - ENGINEER’S DUTIES AND AUTHORITY.**

With reference to Sub-Clause 2.1 (b), the following shall also apply: The Engineer shall obtain the specific approval of the Employer before taking any of the following actions specified in Part 1:

- (a) Consenting to the subletting of any part of the works under Clause 4;
- (b) Certifying additional cost determined under Clause 12;
- (c) Determining an extension of time under Clause 44;
- (d) Issuing a variation under Clause 51;
- (e) Fixing rates or prices under Clause 52
- (f) The works specified under this Contract shall be executed, supervised and evaluated in accordance to the Contract Supervision and Evaluation Manual developed by the Ministry of Roads – Version 2012

## SUBCLAUSE 5.1 - LANGUAGE AND LAW

The Contract document shall be drawn up in the ENGLISH LANGUAGE. Communication between the Contractor and the Engineer's Representative shall be in this given language.

The Laws applicable to this Contract shall be the Laws of the Republic of Kenya.

## SUBCLAUSE 5.2 – PRIORITY OF CONTRACT DOCUMENTS

Delete the documents listed 1-6 and substitute:

- (1) The Contract Agreement (if completed)
- (2) The Letter Of Acceptance;
- (3) The Bid and Appendix to Bid;
- (4) The Conditions of Contract Part II;
- (5) The Conditions of Contract Part I;
- (6) The Special Specifications;
- (7) The Standard Specification for Road and Bridge Construction, 1986;
- (8) The PBC Guidelines Edition 1.1 of February;
- (9) Road Maintenance Manual, May 2010 Edition and Performance Based Contract Manuals.
- (10) The Drawings;
- (11) The priced Bills of Quantities
- (12) Other documents as listed in the Appendix to form of Bid

## SUBCLAUSE 8.2 - Site Operations and Method of Construction

Add

The Contract may be terminated if the Contractor is unable to take full responsibility for the adequacy, stability and safety of all Site operations and methods of construction.

## SUBCLAUSE 10.1 - PERFORMANCE SECURITY

Replace the text of Sub-clause 10.1 with the following:

“The Contractor shall provide security for his proper performance of the Contract within 14 days after receipt of the Letter of Acceptance. The Performance Security shall be in the form of a bank guarantee as stipulated by the Employer in the Appendix to Bid. The Performance Security shall be issued by a bank incorporated in Kenya. The Contractor shall notify the Engineer when providing the Performance Security to the Employer.

“Without limitation to the provisions of the preceding paragraph, whenever the Employer determines an addition to the Contract Price as a result of a change in cost, the Contractor, at the Engineers written request, shall promptly increase the value of the Performance Security by an equal percentage.

## SUBCLAUSE 10.2 - VALIDITY OF PERFORMANCE SECURITY

The Performance Security shall be valid until a date 28 days after the date of issue of the Defects Liability Certificate. The security shall be returned to the Contractor within 14 days of expiration.

Add

The Resident Engineer shall provide a 28days Notice to the Contractor informing him of the early expiry of his Performance Security. Upon receipt of such a Notice the Contractor shall before lapse of 14days extend the Performance security and provide evidence of such an extension to the Resident Engineer. Failure by the contractor to renew his performance Security 7days to its expiry the resident Engineer will Request the Engineer to redeem it. Such a request shall be handled immediately and the performance security recovered.

### SUB CLAUSE 10. 3 - CLAIMS UNDER PERFORMANCE SECURITY

Delete the entire sub-clause 10.3.

The Employer shall be at liberty to claim part or the entire performance Security without informing or notifying the Contractor provided that the conditions necessitating the claim are contractual.

ADD NEW SUBCLAUSE;

### ‘SUBCLAUSE 10. 4 - COST OF PERFORMANCE SECURITY

The cost of complying with the requirements of this clause shall be borne by the Contractor.’

### SUB CLAUSE 11. 1 - INSPECTION OF SITE

In line 17 after “affect his Tender” add

“and the Contractor shall be deemed to have based his BID on all the aforementioned”

Delete the last paragraph completely and replace with the following:

“The Employer in no way guarantees completeness nor accuracy of the soil, materials, subsurface and hydrological information made available to the Contractor at the time of bidding or at any other time during the period of the Contract, and the Contractor shall be responsible for ascertaining for himself all information as aforesaid for the execution of works and his BID shall be deemed to have been priced accordingly.

ADD A NEW SUBCLAUSE;

### ‘SUBCLAUSE 11.2 - ACCESS TO DATA

Data made available by the Employer in accordance with Clause 11.1 shall be deemed to include data listed elsewhere in the Contract as open for inspection at the address stipulated in the Appendix to Bid.’

## SUBCLAUSE 14.1 PROGRAM TO BE SUBMITTED

The time within which the program shall be submitted shall be as specified in the Appendix to the Form of Bid.

This detailed program shall be based upon the program submitted by the Contractor as part of his BID, where this was required, and shall in no material manner deviate from the said program.

The program shall be in the form of a Critical Path Method Network (CPM Network) showing the order of procedure and a description of the construction methods and arrangements by which the Contractor proposes to carry out the works. It should also be supplemented by a time –bar chart of the same program. The program shall be coordinated with climatic, groundwater and other conditions to provide for completion of the works in the order and by the time specified. The program shall be revised at three-month intervals and should include a chart of the principle quantities of work forecast for execution monthly.

The Contractor shall submit to the Engineer not later than the day or date mentioned in the Appendix to the Form of Bid, a general description of his proposed arrangements and methods for the execution of the Works, including temporary offices, buildings, access roads, construction plant and its intended production output, working shift arrangements, labour strength, skilled and unskilled, supervision arrangements, power supply arrangements, supply of materials including a materials utilization program, stone crushing, aggregate production and storage, cement handling, concrete mixing and handling, methods of excavation, dealing with water, testing methods and facilities.

During the execution of the works, the Contractor shall submit to the Engineer full and detailed particulars of any proposed amendments to the arrangements and methods submitted in accordance with the foregoing.

If details of the Contractors proposals for Temporary Works are required by the Engineer for his own information the Contractor shall submit such details within fourteen days of being requested to do so.

The Resident Engineer may at his discretion provide to the Contractor a Format of submitting the Program of Works to comply with the Cashflow projections and budgets assigned to the project

The various operations pertaining to the works shall be carried out in such a progressive sequence as will achieve a continuous and consecutive output of fully completed roadworks inclusive of all bridge works and culverts within the time limits specified in the Contract. Generally the Contractor shall start at one end of the road and progress continuously towards the other without leaving any isolated section or sections of uncompleted road provided always that the site of the works has been acquired in its entirety and the encumbrances and services thereon removed.

The Contractor shall allow in his programme all published Kenya public holidays including but not limited to the following per calendar year during which the Contractor shall not be permitted to work.

- New Years Day (1st January)
- Good Friday
- Easter Monday
- Labour day (1<sup>st</sup> May)
- Madaraka Day (1<sup>st</sup> June)
- The month of Ramadhan
- IddUIFitr
- Mashujaa Day (20<sup>th</sup> October)
- Jamhuri day (12<sup>th</sup> December)
- Christmas Day (25<sup>th</sup> December)

- Boxing day (26<sup>th</sup> December)

The Contractor shall also allow per calendar year for a further 2 unspecified public holidays which may be announced by the Government of Kenya with no prior notification upon which he shall not be permitted to work.

#### SUBCLAUSE 14.2- REVISED PROGRAMME

Add at the end of the first paragraph;

‘Failure by the Contractor to submit the Revised Work Program in the prescribed format and within the stipulated period shall be considered a violation of his contractual obligations and a Notice for Termination shall be issued to the Contractor.’

#### SUBCLAUSE 14.3- CASHFLOW ESTIMATE

The time within which the detailed cash flow estimate shall be submitted shall be as specified in the Appendix to the Form of Bid.

#### SUBCLAUSE 15.1- CONTRACTOR’S SUPERINTENDENCE

Add the following at the end of the first paragraph of sub-clause 15.1:

“The Contractor shall, within Fourteen (14) days of receipt of the Engineer’s order to commence the works inform the Engineer in writing the name of the Contractor’s Representative and the anticipated date of his arrival on site. The Contractor shall also submit a specimen signature of his proposed Site Agent /Road Manager who **SHALL** be the only signatory to payment of certificates/Monthly statements from the Contractor.”

Add the following Sub-clause 15.2

#### ‘SUBCLAUSE 15.2- LANGUAGE ABILITY AND QUALIFICATIONS OF CONTRACTOR’S AUTHORISED AGENT

Unless otherwise stated in the tender document, the Contractor’s Agent or Representative on the site shall have a minimum qualification of a Diploma in Civil/Highway Engineering and shall be able to read and write English fluently.

The Contractor’s Agent or Representative shall have at least 5 years relevant experience as a Site Agent or equivalent.

#### SUBCLAUSE 16.1- CONTRACTOR’S EMPLOYEES

Payment of Monthly Salaries/allowances to Contractor's employees and allowances due to all officers seconded by the Engineer to the assignment shall be made on or before the Fifth (5th) day of the following month.

Failure to comply with the above, shall attract a penalty of KSh. 50,000.00 per day for the period salaries/allowances are delayed.

The penalties accrued under this clause shall be deducted from any sums due to the contractor during the preparation of the interim payment certificate.

#### SUBCLAUSE 16.2- ENGINEER AT LIBERTY TO OBJECT

At the end of this Clause add

“by a competent substitute approved by the Engineer and at the Contractors own expense.”

Add the following Sub-Clauses 16.3 and 16.4:

#### ADD THE FOLLOWING SUB-CLAUSE

##### ‘SUBCLAUSE 16.3- QUALIFICATION AND LANGUAGE ABILITY OF SUPERINTENDING STAFF

Unless otherwise stated in the Tender document, the Contractor's superintending staff shall meet the following minimum qualifications:

Should have a working knowledge of English or Kiswahili. Should any of the superintending staff not be able to meet this condition, the Contractor shall propose to the Engineer arrangements for provision of a sufficient number of interpreters of approved qualifications. The Engineer, at his discretion, may amend, approve or reject such arrangements or reject deployment of superintending staff not meeting the language requirements. The Engineer may at any time during the duration of the Contract amend any approved arrangements made for interpreters, which shall be implemented at the Contractors expense.

The key staff listed below must have academic qualifications from government-recognised institutions or equivalent institutions of the levels set out in Section 5, Part 6.

- Site Agent /Road Manager

Qualifications as above shall be subject to verification and approval on site by the Engineer or his representative on site before commencement of the said works.’

#### SUBCLAUSE 16.4 – EMPLOYMENT OF LOCAL PERSONNEL

The Contractor is encouraged, to the extent practicable and reasonable, to employ staff and labour with appropriate qualifications and experience who are Kenya citizens.

#### SUBCLAUSE 19.1- SAFETY, SECURITY AND PROTECTION OF THE ENVIRONMENT

Add Paragraph (d) of Sub-Clause 19.1 as follows:

Notwithstanding the Contractor's obligation under Sub-Clause-paragraph (a), (b) and 9(c) of Sub-Clause 19.1 of the Conditions of Contract, the Contractor shall observe the following measures with a view to reducing or elimination adverse environmental effects by the site works:

- (i) All quarries and borrow pits shall be filled and landscaped to their original state after extraction of construction material
- (ii) Soil erosion due to surface runoff or water from culverts or other drainage structures should be avoided by putting in place proper erosion control measures that shall include, but are not limited to grassing and planting if trees
- (iii) Long traffic diversion roads shall be avoided so as to minimize the effect of dust on the surrounding environment. In any case all diversions shall be kept damp and dust free
- (iv) Spillage of oils, fuels and lubricants shall be avoided and if spilt, shall be collected and disposed off in such a way as not to adversely affect the environment
- (v) Rock blasting near settlement areas shall be properly coordinated with the relevant officers of the Government so as to minimize noise pollution and community interference.

• **Traffic Management Plan**

- i. The Contractor should identify, evaluate and monitor potential traffic and road safety risks to workers and road users throughout the Contract life cycle and develop measures and plans to address them.
- ii. The Contractor shall install and maintain standard approved traffic warning signs, directional signs, secure the working areas and deploy flagmen at active construction sites.
- iii. The Contractor shall assess each phase of the works, monitor incidents and accidents indicating the mitigation measures undertaken and prepare monthly reports to be submitted to the Resident Engineer.
- iv. The Contractor shall factor the cost of implementation of the Road Safety Plan in the rates for the Works.

Failure by the Contractor to implement the measures under approved safety plan shall be deemed to be a violation of the Contractor's Obligations under the Contract and shall be grounds for charging a penalty of up to **KES 50,000.00** per day for non-compliance. The penalties will be as shown below:

	<b>SAFETY REQUIREMENT</b>	<b>AMOUNT OF PENALTIES PER DAY (KSh.)</b>
1.	Personal Protective Equipment	10,000.00
2.	Approved Signage e.g. warning signs etc.	15,000.00
3.	Construction site delineation and passage of traffic through works	15,000.00
4.	Safety for passage of traffic at Night	10,000.00

**SUBCLAUSE 20.4 - EMPLOYERS RISKS**

Delete Sub-Clause (h) and substitute with;

- (h) any operation of the forces of nature (insofar as it occurs on site) which an experienced contractor:
  - (ii) could not have reasonably foreseen, or
  - (iii) could reasonably have foreseen, but against which he could not reasonably have taken at least one of the following measures:
    - (A) prevent loss or damage to physical property from occurring by taking appropriate measures or
    - (B) insure against such loss or damage

## SUBCLAUSE 21.1 - INSURANCE OF WORKS AND CONTRACTOR 'S EQUIPMENT

Delete the first sentence of this Clause and replace with the following:

“prior to commencement of the Works the Contractor shall, without limiting his or the Employer’s obligations and responsibilities under Clause 20, insure to the satisfaction of the Employer:”

Add the following words at the end of Sub-paragraph (a) and immediately before the last word of Sub-paragraph (b) of Sub-Clause 21.1:

“It being understood that such insurance shall provide for compensation to be payable in the types and proportions of currencies required to rectify the loss or damage incurred”

## SUBCLAUSE 21.2 – SCOPE OF COVER

Amend sub-paragraph (a) of Sub-Clause 21.2 as follows:

Delete words “from the start of work at the site” and substitute the words “from the first working day after the Commencement Date”

Add the following as Sub-Clause (c) under Sub-Clause-Clause 21.2

(c ) It shall be the responsibility of the Contractor to notify the insurance company of any change in the nature and extent of the Works and to ensure the adequacy of the insurance coverage at all times during the period of the Contract.

Add

The Contractor shall be expected to insure all road assets from damage and to pursue the insurance companies as and when damages to these assets occur. In addition, the Contractor is expected to furnish the Engineer with a copy of Insurance Policy of WIBA at the commencement of works.

## SUB CLAUSE 21.4 - EXCLUSIONS

Amend Sub-Clause 21.4 to read as follows:

“There shall be no obligation for the insurances in Sub-Clause 21.1 to include loss or damage caused by the risks listed under Sub-Clause 20.4 sub-paragraph (a) (i) to(iv) of the Conditions of Particular Application.”

## SUBCLAUSE 23.2 – MINIMUM AMOUNT OF INSURANCE

Add the following at the end of this Clause:

“.. with no limits to the number of occurrences”.

## SUBCLAUSE 25.1 – EVIDENCE AND TERMS

Amend Sub-Clause OF INSURANCE 25.1 as follows:

Insert the words “as soon as practicable after the respective insurances have been taken out but in any case” before the words “prior to the start of work at the site”

Add the following Sub-Clauses 25.5, 25.6

## SUBCLAUSE 25.5 – INSURANCE NOTICES

Each policy of insurance effected by the Contractor for purposes of the Contract shall include a provision to the effect that the Insurer shall have a duty to give notice in writing to the Contractor and Employer of the date when a premium becomes payable. This shall not be more than thirty (30) days before that date and the policy shall remain in force until thirty (30) days after the giving of such notice.

## SUBCLAUSE 25.6 – NOTIFICATION TO INSURERS

It shall be the responsibility of the Contractor to notify insurers under any of the insurance referred to in the preceding clauses 21, 23 and 24 on any matter or event, which by the terms of such insurance are required to be so notified. The Contractor shall indemnify and keep indemnified the Employer against all losses, claims, demands, proceedings, costs, charges and expenses whatsoever arising out of or in consequence of any default by the Contractor in complying with the requirements of this Sub-Clause whether as a result of avoidance of such insurance or otherwise.

## SUBCLAUSE 28.2 – ROYALTIES

Add at the end of this Sub-Clause the following sentence:

“The Contractor shall also be liable for all payments or compensation if any that are levied in connection with the dumping of part or all of any such material.”

Add

The Contractor shall be solely responsible for any Cess and any other fees that the County/Region May levy on materials, goods or transportation within the Region

## SUBCLAUSE 29.1 – INTERFERENCE WITH TRAFFIC

Supplement Sub-Clause 29.1 by adding the following sentence at the end:

“The Contractor will be permitted to use existing public roads for access to the site. The Contractor shall pay vehicle license tax and road maintenance duty in accordance with relevant regulations and shall obtain any necessary permits or licenses from relevant authorities for transporting his equipment.”

Add the following subclause 29.2:

#### SUBCLAUSE 29.2 – REINSTATEMENT AND COMPENSATION FOR DAMAGES TO PERSONS AND PROPERTY

The Contractor shall reinstate all properties whether public or private which are damaged in consequence of the construction and, maintenance of the works to a condition as specified and at least equal to that prevailing before his first entry on them.

If in the opinion of the Engineer the Contractor shall have failed to take reasonable and prompt action to discharge his obligations in the matter of reinstatement, the Engineer will inform the Contractor in writing of his opinion, in which circumstances the Employer reserves the right to employ others to do the necessary work of reinstatement and to deduct the cost thereof from any money due or which shall become due to the Contractor.

The Contractor shall refer to the Employer without delay all claims which may be considered to fall within the provisions of Clause 22.1.

Add the following Sub-Clause 34.2 to 34.8

#### SUBCLAUSE 34.2 – CONDITIONS OF EMPLOYMENT OF LABOUR

The Contractor shall be responsible for making all arrangements for and shall bear all costs relating to recruitment, obtaining of all necessary visas, permits or other official permission for movements of staff and labour.

#### SUBCLAUSE 34.3 – FAIR WAGES

The Contractor shall, in respect of all persons employed anywhere by him in the execution of the Contract, and further in respect of all persons employed by him otherwise than in the execution of the Contract in every factory, Workshop or place occupied or used by him for the execution of the Contract, observe and fulfil the following conditions:

(a) The Contractor shall pay rates of wages, observe hours of labour and provide conditions of labour, housing, amenities and facilities not less favourable than those required by the latest Regulation of Wages (Building and Construction Industry) Order as of the time of bid submission, and subsequent amendments thereto, or in any wage scales, hours of work or conditions agreed by the Ministry of Labour or other Government Department in consultation with the appropriate wage fixing authority and generally recognized by other employees in the district whose general circumstances in the trade or industry in which the Contractor is engaged are similar.

(b) In the absence of any rates of wages, hours or conditions of labour so established the Contractor shall pay rates of wages and observe hours and conditions of labour which are not less favourable than the general level of wages, hours and conditions observed by other Employers whose general circumstances in the trade or industry in which the Contractor is engaged are similar.

(c) Where the absence of established rates of wages, hours and conditions of labour or the dissimilarity of the general circumstances in the trade of industry in which the Contractor is engaged prevent the Contractor from observing rates of wages, hours and conditions of labour ascertained under sub-paragraph (a) and (b) above the Contractor in fixing the rates of wages, hours and conditions of labour of his employees shall be guided by the advice of the Labour Department.

(d) The Contractor shall recognize the freedom of his employees to be members of trade unions.

(e) The Contractor shall maintain records in English of the time worked by, and the wages paid to, his employees. The Contractor shall furnish to the Engineer or Employer, if called upon to do so, such particulars of the rates, wages and conditions of labour as the Employer or Engineer may direct.

(f) The Contractor shall at all times during the continuance of the contract display, for the information of his employees in every factory, workshop or place occupied or used by him for the execution of the Contract, a copy of this clause together with a notice setting out the general rates of wages, hours and conditions of labour of his employees.

(g) The Contractor shall be responsible for the observance of this clause by sub-Contractors employed in the execution of the works.

#### SUBCLAUSE 34.4 – BREACH OF FAIR WAGES CLAUSE

Any Contractor or Sub-Contractor who is found to be in breach of Fair Wages Clause shall cease to be approved as a Contractor or Sub-Contractor for such period as the Permanent Secretary for the Ministry of Transport and Infrastructure may determine.

Should a claim be made to the Employer alleging the Contractor's default in payment of Fair Wages of any workman employed on the Contract and if proof thereof satisfactory to the Employer is furnished by the Labour Authority, the Employer may, failing payment by the Contractor, pay the claims out of any monies due or which may become due to the Contractor under the Contract.

#### SUBCLAUSE 34.5 – RECRUITMENT OF UNSKILLED LABOUR

Any additional unskilled labour which is required by the Contractor for the works and which is not in his employ at the time of the acceptance of the BID shall be recruited by the Contractor from the Labour Exchange or Exchange or Exchanges nearest to the site or sites of the work.

#### SUBCLAUSE 34.6 – COMPENSATION FOR INJURY

The Contractor shall in accordance with the Workmen's Compensation Act of the Laws of Kenya and any other regulations in force from time to time pay compensation for loss or damage suffered in consequence of any accident or injury or disease resulting from his work to any workman or other person in the employment of the Contractor or any Subcontractor.

#### SUBCLAUSE 34.7 – LABOUR STANDARDS

(a) the Contractor shall comply with the existing local labour laws, regulations and labour standards

(b) the Contractor shall formulate and enforce an adequate safety program with respect to all work under his contract, whether performed by the Contractor or subcontractor. The Contractor has assurance from the Employer of cooperation where the implementation of these safety measures requires joint cooperation.

(c) Upon written request of the Employer the Contractor shall remove or replace any of his employees employed under this Contract.

Add the following Sub-Clause 35.2 and 35.3.

#### **SUBCLAUSE 35.2 – RECORDS OF SAFETY AND HEALTH**

The Contractor shall maintain such records and make such reports concerning safety, health and welfare of persons and damage to property as the Engineer may from time to time prescribe.

#### **SUBCLAUSE 35.3 – REPORTING OF ACCIDENTS**

The Contractor shall report to the Engineer details of any accident as soon as possible after its occurrence. In the case of any fatality or serious accident, the Contractor shall, in addition, notify the Engineer immediately by the quickest available means. The Contractor shall also notify the relevant authority whenever the Laws of Kenya require such a report.

#### **SUBCLAUSE 41.1 – COMMENCEMENT OF WORKS**

Amend Sub-Clause 41.1 as follows:

Delete the words “as soon as is reasonably possible” in the first sentence and replace with “within the period stated in the Appendix to Bid”.

#### **SUBCLAUSE 43.1 – TIME FOR COMPLETION**

Amend Sub-Clause 43.1 as follows:

Delete the words “within the time” to “such extended time” and substitute “by the date or dates stated or implied in Clause 14 of these Conditions of Particular Application.

#### **SUBCLAUSE 44.1 – EXTENSION OF TIME FOR COMPLETION**

Add at the end of Sub-Clause 44.1 the following:

“Neither rains falling within the rainy seasons as occurs in Kenya nor floods caused by such rains shall be deemed exceptional weather conditions such as may fairly entitle the Contractor to an extension of time for the completion of the work.”

“The Contractor shall not be entitled to any claims on VOP or extra monies due to Extension of Time awarded unless the delays causing the extension of time are caused by the Employer.”

#### SUBCLAUSE 45.1 – RESTRICTION ON WORKING HOURS

Add at the end of Sub-Clause 45.1 the following:

“If the Contractor requests permission to work by night as well as by day, then if the Engineer shall grant such permission the Contractor shall not be entitled to any additional payments for so doing. All such work at night shall be carried out without unreasonable noise or other disturbance and the Contractor shall indemnify the Employer from and against any liability for damages on account of noise or other disturbance created while or in carrying out night work and from and against all claims, demands, proceedings, costs, charges and expenses whatsoever in regard or in relation to such liability.

“In addition, the Contractor will be required to provide, for any work carried out at night or recognized days of rest, adequate lighting and other facilities so that the work is carried out safely and properly.

“In the event of the Engineer granting permission to the Contractor to work double or rotary shifts or on Sundays, the Contractor shall be required to meet any additional costs to the Employer in the administration and supervision of the Contract arising from the granting of this permission.”

#### SUBCLAUSE 47.1(B) – PENALTY FOR NOT ATTENDING TO POTHOLES

“If the Contractor trims/excavates any single pothole for repair and fails to seal it with AC within a period of 48 hours from the time of the excavation, penalty shall be charged to the contractor in the next due certificate at a rate specified in the Appendix to form of bid per pothole.

#### SUBCLAUSE 47.2 – REDUCTION OF LIQUIDATED DAMAGES

Add the following paragraphs at the end of this Sub-Clause:

“There shall be no reduction in the amount of liquidated damages in the event that a part or a section of the Works within the Contract is certified as completed before the whole of the Works comprising that Contract.

The Employer shall pay no bonus for early completion of the Works to the Contractor.

The sum stated in the Appendix to Bid as liquidated damages shall be increased by a sum equivalent to any additional amount payable by the Employer to the Contractor under clause 70.1 in respect of an increase in costs in such a period that would not have been incurred by the Contractor if the works had been completed by the due date for completion prescribed by Clause 43.”

Add

The Employer may, without prejudice to any other method of recovery, deduct the amount of such damages from any monies due or to become due to the Contractor, and after the limit of deduction prescribed in the Appendix to tender is reached, the Contract shall be considered due for Termination.

### SUBCLAUSE 48.3 – SUBSTANTIAL COMPLETION OF PARTS

In Hybrid PBC Works Contracts, when Instructed works are substantially completed, the same works shall be taken over and shall be considered complete.

### SUBCLAUSE 49.1 – DEFECTS LIABILITY PERIOD

Defects liability period shall start for Instructed works immediately the works are certified as Complete by the Engineer. The period of Defects liability shall be prescribed in the Appendix to the Contract.

### SUBCLAUSE 49.2 – COMPLETION OF OUTSTANDING WORK AND REMEDYING DEFECTS

Add

At the time of End of Defects Liability Inspection, no defect arising from the permanent works existing shall be acceptable for taking over. The Inspection team shall verify and satisfy themselves that all the outstanding works and defects arising out of the works have been attended to sufficiently. Routine Maintenance works/PBC Works shall also be inspected at the time of End of Defects Liability Inspection and should comply to the specifications of the PBC Works.

### SUBCLAUSE 51.1 – VARIATIONS

Add the following at the end of the last paragraph

No such variations in any way shall contravene the requirements of Public Procurement and Disposal Act of 2015 and the amendments thereof.

### SUBCLAUSE 52.1 – VALUATION AND VARIATIONS

Add new Clause 52.2(c)

No change in the unit rates or prices quoted shall be considered for items included in the schedule of Dayworks rates, or Provisional Sums and items, or for any item in the BOQ.

Add new clause 52.3

### SUBCLAUSE 52.3 – VARIATIONS EXCEEDING 25 PERCENT

Subject to requirements of Public Procurement and Disposal Act of 2015 and the amendments thereof, variations above 25 percent critical to the proper function of the completed works and without which part or whole of already specified work in the bill of quantities cannot be adequately executed may constitute ground for Contract termination by either parties.

In which case, the Engineer shall give 28-day notice to the Contractor with a copy to the Employer of such occurrence. The Contract shall terminate at the expiry of the notice.

#### SUBCLAUSE 52.4 – DAYWORKS

Add the following at the end of Sub-Clause 52.4:

The work so ordered shall immediately become part of the works under the contract. The Contractor shall, as soon as practicable after receiving the Dayworks order from the Engineer undertake the necessary steps for due execution such work. Prior to commencement of any work to be done on a Dayworks basis, the Contractor shall give an advance notice to the Engineer stating the exact time of such commencement.

#### SUBCLAUSE 54.1 – CONTRACTOR’S EQUIPMENT, TEMPORARY WORKS AND MATERIALS : Exclusive use for the works

Amend Sub-Clause 54.1 as follows:

Line 5: add “written” between “the” and “consent”.

Delete Sub-Clauses 54.2 and 54.5.

Add

The Contractor shall be at liberty to deliver and withdraw equipment as and when needed for the undertaking of works under this contract according to the equipment deployment schedule and work program approved. If a particular equipment is required and the contractor is unable at the required time to avail the said equipment, the contractor shall be expected to notify the Engineer of the possible reasons and adjustments made to such delays. No Provisions shall be made for any claims on Idle Equipment.

#### SUBCLAUSE 55.2 – OMMISIONS OF QUANTITIES

Items of Works described in the Bills of Quantities for which no rate or price has been entered in the Contract shall be considered as included in other rates and prices in the Contract and will not be paid for separately by the Employer.

Add the following Sub-Clause 58.4:

#### SUBCLAUSE 58.4 – PROVISIONAL ITEMS

Provisional items shall be read as Provisional Sums and shall be operated as such in accordance with Sub-Clauses 58.1 to 58.3.

Clause 60 of the General Conditions is deleted and substituted with the following: -

#### SUBCLAUSE 60.1 – MONTHLY STATEMENT

The Contractor shall submit a statement to the Engineer at the end of each month, in a tabulated form approved by the Engineer, showing the amounts to which, the Contractor considers himself to be entitled. The statement shall include the following items, as applicable;

- the value of the Permanent Work executed up to the end of previous month
- such an amount (not exceeding 75 percent of the value) as the Engineer may consider proper on account of materials for permanent work delivered by the Contractor in the site
- such amount as the Engineer may consider fair and reasonable for any Temporary Works for which separate amounts are provided in the Bill of Quantities
- adjustments under Clause 70
- any amount to be withheld under retention provisions of Sub-clause 60.3
- any other sum to which the Contractor may be entitled under the Contract

If the Engineer disagrees with or cannot verify any part of the statement, the Contractor shall submit such further information as the Engineer may reasonably require and shall make such changes and corrections in the statement as may be directed by the Engineer. In cases where there is difference in opinion as to the value of any item, the Engineer's view shall prevail. In case the Contractor fails to submit the statements, the Engineers Progress report shall form the Contractor's statement.

#### SUBCLAUSE 60.2 INTERIM PAYMENT CERTIFICATE

The Contractor shall forward to the Engineer an Interim Payment Certificate based on the statement as corrected above and, should it be necessary in the Engineers opinion, shall promptly make any further amendments and corrections to the Interim Payment Certificate.

The Engineer shall not unreasonably withhold certifying an Interim Payment Certificate and in case of likely delay in establishing the value of an item, such item may be set aside and the remainder certified for payment.

Within 45 days after receipt of the Interim Payment Certificate and subject to the Contractor having made such further amendments and corrections as the Engineer may require, the Engineer will forward to the Employer the certified Interim Payment Certificate.

Provided that the Engineer shall not be bound to certify any payment under this Clause if the net amount thereof, after all retentions and deductions, would be less than the minimum amount of Interim Payment Certificate's stated in the Appendix to Form of Bid. However, in such a case, the uncertified amount will be added to the next interim payment, and the cumulative unpaid certified amount will be compared to the minimum amount of interim payment.

#### SUBCLAUSE 60.3 – PAYMENT OF RETENTION MONEY

A retention amounting to the percentage stipulated in the Appendix to Bid shall be made by the Engineer in the first and following Interim Payment Certificates until the amount retained shall reach the "Limit of Retention Money" named in the Appendix to Form of BID.

Upon the issue of the Taking-Over Certificate, with respect to the whole of the works one half of the retention money shall become due and shall be paid to the Contractor when the Engineer shall certify in writing that the last section of the whole works has been substantially completed.

Upon expiration of the Defects Liability Period for the works, the other half of the Retention Money shall be certified by the Engineer for payment to the Contractor.

Provided that in the event of different Defects Liability Periods being applicable to different Sections of the Permanent Works pursuant to Clause 48, the expression "expiration of the Defects Liability Period" shall, for the purpose of this sub-clause, be deemed to mean the expiration of the latest of such periods.

Provided also that if at such time, there remain to be executed by the Contractor any work instructed, pursuant to Clause 49 and 50, in respect of the works, the Engineer shall be entitled to withhold certification until completion of any such work or so much of the balance of the Retention money as shall in the opinion of the Engineer, represents the cost of the remaining work to be executed.

#### SUBCLAUSE 60.4– CORRECTION OF CERTIFICATES

The Engineer may in any Interim Payment Certificate make any correction or modification to any previous Interim Payment Certificate signed by him and shall have authority, if any work is not being carried out to his satisfaction to omit or reduce the value of such work in any Interim Payment Certificate.

#### SUBCLAUSE 60.5– STATEMENT AT COMPLETION

Not later than 84 days after the issue of the Taking-Over Certificate in respect of the whole of the works, the Contractor shall submit to the Engineer a statement at completion showing in detail, in a form approved by the Engineer;

The final value of all work done in accordance with the Contract up to the date stated in such Taking-Over Certificate.

Any further sums which the Contractor considers to be due; and

An estimate of amounts that the Contractor considers will become due to him under the Contract.

Estimate amounts shall be shown separately in the Statement at Completion. The Contractor shall amend and correct the Statement as directed by the Engineer and submit a Certificate at Completion to be processed as in Sub-Clause 60.2.

#### SUBCLAUSE 60.6 – FINAL STATEMENT

Not later than 56 days after the issue of the Defects Liability Certificate pursuant to Sub-Clause 62.1, the Contractor shall submit to the Engineer for consideration a draft final statement with supporting documents showing in detail, in the form approved by the Engineer;

The final value of all work done in accordance with the Contract;

Any further sums which the Contractor considers to be due to him.

If the Engineer disagrees with or cannot verify any part of the draft final statement, the Contractor shall submit such further information as the Engineer may reasonably require and shall make such changes in the draft as may be required.

#### SUBCLAUSE 60.7– DISCHARGE

Upon submission of the Final Statement, the Contractor shall give to the Employer, with a copy to the Engineer, a written discharge confirming that the total of the Final statement represents full and final settlement of all monies due to the Contractor arising out of or in respect of the Contract. Provided that such discharge shall become effective only after payment under the Final Payment Certificate issued pursuant to Sub-Clause 60.8 has been made and the Performance Security referred to in Sub-Clause 10.1 has been returned to the Contractor.

#### SUBCLAUSE 60.8 – FINAL PAYMENT CERTIFICATE

Upon acceptance of the Final Statement as given in Sub-Clause 60.6, the Engineer shall prepare a Final Payment Certificate which shall be delivered to the Contractor's authorized agent or representative for his signature. The Final Payment Certificate shall state:

The final value of all work done in accordance with the Contract;

After giving credit to the Employer for all amounts previously paid by the Employer, the balance, if any, due from the Employer to the Contractor or the Contractor to the Employer.

Final Certificate shall be issued for any sum due to the Contractor even if such is less than the sum named in the Appendix to the Form of BID.

#### SUBCLAUSE 60.9– CESSATION OF EMPLOYERS LIABILITY

unless the Contractor notifies the Engineer of his objection to the Final Certificate within fourteen days of delivery thereof, he shall be deemed to have agreed that he accepts the total Contract Price as set out in the Final Certificate as full settlement for all Work Done under the Contract including any variations and omissions thereof but excluding any variations and claims previously made in writing.

#### SUBCLAUSE 60.10 – TIME FOR PAYMENT

The amount due to the Contractor under any Interim Payment Certificate or Final Payment Certificate issued pursuant to this Clause or to any other term of the Contract, shall, subject to Clause 47, be paid by the Employer to the Contractor as follows:

- (i) In the case of Interim Payment Certificate, within the time stated in the Appendix to Form of Bid, after the Engineer has signed the Interim Payment Certificate.
- (i) In the case of the Final Payment Certificate pursuant to Subclause 60.8, within the time stated in the Appendix to Form of Bid, after the Engineer has signed the Final Payment Certificate.
- (ii) In the event of the failure of the Employer to make payment within the times stated, the Employer shall make payment to the Contractor of simple interest at a rate equal to two percentage points above the average Base Lending Rate of three leading banks namely Kenya Commercial Bank, Standard Chartered Bank and Barclays Bank for the time being or as shall be the case from the time to time obtained from the Central Bank of Kenya. The provisions of this subclause are without prejudice to the Contractor's entitlements under Clause 69 or otherwise.

#### SUBCLAUSE 60.11 – CURRENCY OF PAYMENT

The Contract Price shall be designated in Kenyan Currency.

All work performed by the Contractor under the Contract shall be valued in Kenya Shillings using the rates and prices entered in the Bills of Quantities together with such other increases to the Contract Price, except for variation of price payments in accordance with Clause 70.1.

#### SUBCLAUSE 60.12 – ADVANCE PAYMENT

Delete the entire clause

#### SUBCLAUSE 60.13 MATERIALS FOR PERMANENT WORKS

With respect to materials brought by the Contractor to the site for incorporation into the permanent works, the Contractor shall,

-Receive a credit in the month in which these materials are brought to site,

-Be charged a debit in the month in which these materials are incorporated in the permanent works.

Both such credit and debit to be determined by the Engineer in accordance with the following provisions.

No credit shall be given unless the following conditions shall have been met to the Engineers satisfaction

The materials are in accordance with the specifications for the works;

The materials have been delivered to site and are properly stored and protected against loss, damage or deterioration;

The Contractors record of the requirements, orders receipts and use of materials are kept in a form approved by the Engineer and such records are available for inspection by the Engineer;

The Contractor has submitted a statement of his cost of acquiring and delivering the materials and plant to the Site, together with such documents as may be required for the purpose of evidencing such cost;

The materials are to be used within a reasonable time.

The amount to be credited to the Contractor shall not be more than 75% of the Contractor's reasonable cost of the materials delivered to site, as determined by the Engineer after review of the documents listed in subparagraphs (a) (iv) above;

The amount to be debited to the Contractor for any materials incorporated into the works shall be equivalent to the credit previously granted to the Contractor for such materials pursuant to Clause (b) above as determined by the Engineer.

#### SUBCLAUSE 63.1

Add

is unable to take full responsibility for the adequacy, stability and safety of all Site operations and methods of construction as stipulated in subclause 8.2 of the conditions of contract.

- a) Fails to comply with Subclause 10.1 and 10.2 of the Conditions of Contract
- b) Fails to comply with Subclause 14.2 and Subclause 14.3 of the Conditions of Contract and Appendix to Form of Bid.
- c) Fails to observe the safety as stipulated in Subclause 19.1 and amendments therein.
- d) Fails to Conform to Service levels as detailed in the Appendix to Form of Bid and as required in subclause 13.1.
- e) Incurs the maximum amount of Liquidated damages as stated in the Appendix to Form of Bid or the liquidated damages amount, exceeds the performance security then the contract would be automatically Terminated.
- f) Has not completed the works despite the lapse of the Contract Period as stated in the Appendix to form of Bid

#### SUBCLAUSE 67.1 – ENGINEER'S DECISION

Delete the entire sub clause 67.1 and add the following;

“If a dispute of any kind whatsoever arises between the Employer and the Contractor in any connection with, or arising out of, the Contract or the execution of the works, whether during the execution of the works or after their completion and whether before or after repudiation or other termination of the Contract including any dispute as to any opinion, instruction, determination, certificate or valuation of the Engineer, the matter in dispute shall, in the first place, be referred in writing to the Engineer, with a copy to the other party. Such reference shall state it is made pursuant to this clause. No later than 28 (twenty-eight) day after the day on which he received such reference the Engineer shall give notice of his decision to the Employer and the Contractor. Such decision shall state it is made pursuant to this clause.

Unless the Contract has already been repudiated or terminated, the Contractor shall, in every case, continue to proceed with the works with all due diligence and the Contractor and the Employer shall give effect forthwith to every such decision of the Engineer unless and until the same shall be revised, as hereinafter provided, in an Amicable Settlement, Adjudicator’s or Arbitrator’s award.

If either the Employer or the Contractor be dissatisfied with the any decision of the Engineer, or if the Engineer fails to give notice of his decision on or before the 28th (twenty eighth) after the day on which he received the reference, then either the Employer or the Contractor may, on or before the 28th (twenty eighth) day after the day the day on which he received notice of such decision, or on or before the 28th (twenty eighth) day after the day the day on which the said period of 28 days expired, as the case may be, give notice to the other party, with a copy for information to the Engineer, of his intention to commence Adjudication, as hereinafter provided, as to the matter in dispute. Such notice shall establish the entitlement of the party giving the same to commence Adjudication, as hereinafter provided, as to such dispute; no adjudication in respect thereof may be commenced unless such notice is given.

If the Engineer has given notice of his decision as to a matter in dispute to the Employer and the Contractor and no notice of intention to commence adjudication as to such dispute has been given by either the Employer or the Contractor on or before the twenty eighth day after the day on which the parties received notice as to such decision from the Engineer, the said decision shall become final and binding upon the Employer and the Contractor. “

#### SUBCLAUSE 67.2 – AMICABLE SETTLEMENT

Delete the entire sub clause 67.2 and add the following;

“Where notice to of intention to commence adjudication as to a dispute has been in accordance with sub clause 67.1, the parties shall attempt to settle such dispute in amicably before the commencement of Adjudication; provided that, unless the parties otherwise agree, Adjudication may be commenced on or after the 14th (fourteenth) day after the day on which notice of intention to commence adjudication of such dispute was given, even if an attempt at amicable settlement thereto has been made.”

#### SUBCLAUSE 67.3 – ADJUDICATION

Delete the entire sub clause 67.3 and add the following;

“The Adjudicator shall be appointed by the Chartered Institute of Arbitrators (Kenya) unless the appointment is agreed by the parties within 7 (seven) days of the notice to adjudication.

The adjudication process shall be conducted according to the Laws of Kenya and the Rules of the Chartered Institute of Arbitrators (Kenya).”

#### SUBCLAUSE 67.3 – ARBITRATION

Delete the entire sub clause 67.3 and add the following;

“Any dispute in respect of which:

The decision, if any, of the Adjudicator has not become final and binding pursuant to sub clause 67.1, and Amicable settlement has not been reached within the period stated in sub clause 67.2,

shall be finally settled, under the Laws of Kenya and the Arbitration Rules of the Chartered Institute of Arbitrators (Kenya Branch) by one or more arbitrators appointed by the Chartered Institute of Arbitrators (Kenya Branch).

Neither party shall be limited in the in the proceedings before such arbitrator/s to the evidence or arguments put before the Adjudicator for the purpose of obtaining his said decision pursuant to sub clause 67.1.

Arbitration may be commenced prior to or after completion of the works, provided that the obligations of the Employer, the Engineer and the Contractor shall not be altered by reason of the arbitration being conducted during the progress of the works.

#### SUBCLAUSE 68.2 – NOTICES TO EMPLOYER AND ENGINEER

Delete in Sub-Clause 68.2 the words "nominated for that purpose in Part II of these conditions".

- a. The Employer’s address is:  
The Director General,  
  
Kenya National Highways Authority (KeNHA),  
  
P.O. Box 49712 - 00100  
  
**NAIROBI**
  
- b. The Engineer’s address is:  
Director,  
  
Maintenance,

Kenya National Highways Authority (KeNHA),

P.O. Box 49712 - 00100

**NAIROBI**

SUBCLAUSE 68.4 – All letters and notices from the Contractor to the Employer and/Engineer must be signed by the Managing Director or the person given written power of Attorney.

In addition to the usual postal office contacts the tenderer is required to provide official email address to be used to communicate urgent letters requiring timely responses from the tenderer like tender addendum (addenda), award letter or any other deemed urgent from the Employer requiring timely preparation and reply.

#### CLAUSE 69 – DEFAULT OF EMPLOYER

Delete Sub-Clause 69.1 (c)

In Sub-Clause 69.4 add at the end of first paragraph the following “the period of such suspension shall be as agreed upon by both parties and in any case not more than six (6) months”.

In Subclause 69.4 of General Conditions of Contract Part I, insert at the end -----“The amounts of such costs which shall be added to the Contract Price shall exclude any cost due to idle time for equipment, plant and labour.”

#### CLAUSE 70 – CHANGES IN COST AND LEGISLATION

##### *SUB-CLAUSE 70.1 – INCREASE OR DECREASE OF COST*

Delete Sub-Clause 70.1 of part 1 in its entirety and substitute the following:

*“The Contract Price shall be deemed to have been calculated in the manner set below and shall be subject to the adjustment in the event specified hereunder:*

*Variation of prices shall be applicable Eighteen (18) months after the signing of the contract.*

*The monthly statements prescribed under sub-clause 60.1 shall be used in computation of the price adjustment.*

*The rates contained in the priced Bills of Quantities are based upon the rates of wages and other emoluments and expenses applicable at the site at the date of Bid pricing (as defined in Sub-Clause 70.4 hereinafter);*

- (a) If the said rates of wages and other emoluments and expenses shall be increased or decreased by Act, Statute, Decree, Regulation and the like after the said Date of Bid Pricing then the net amount of increase or decrease the emoluments and expenses shall, as the case may be, be paid to or allowed by the Contractor;
- (b) The rates contained in the priced Bills of Quantities are based upon the rates of the Contractor’s compulsory contributions payable at the date of Bid under or by virtue of any Act, Statute, Regulations and the like applicable at the site;
- (c) If any of the said rates of contribution shall be increased or decreased by any Act, Statute, Decree, Regulation and the like after the said Date of Bid Pricing, or if any new statutory contribution becomes payable after that date then the net amount of increase or decrease of the emoluments and expenses shall, as the case may be, be paid to or allowed by the Contractor. The difference between what the Contractor actually pays in respect of work people engaged upon or in connection with the works and what he would

have paid in respect of such person had any of the said rates not been increased or decreased or had a new contribution not become payable as aforesaid, shall as the case may be, be paid to or allowed by the Contractor. The formulae for this price adjustment shall be of the following type;

$$pn = A + b \frac{Bn}{Bo} + c \frac{Cn}{Co} + d \frac{Dn}{Do} + e \frac{En}{Eo} + f \frac{Fn}{Fo}$$

where:

- Pn* Price adjustment factor
- A* Fixed constant specified in the appendix to Bid
- b* Weighting for Labour
- c* Weighting for Fuel and lubricants
- d* Weighting for Plant and spares
- e* Weighting for cement
- f* Weighting for Bitumen products
  
- Bo* base cost index for Labour
- Co* Base cost index for fuel and lubricants
- Do* Base cost index for plant and spares
- Eo* Base cost for cement
- Fo* Base cost for Bitumen products
  
- Bn* Current cost index for Labour
- Cn* Current cost index for fuel and lubricants
- Dn* Current cost index for plant and spares
- En* Current cost index for cement
- Fn* Current cost for Bitumen products

- (d) The rates contained in the priced Bills of Quantities are based upon the market prices of the materials and goods specified in the Schedule of Basic Materials (Schedule G) attached hereto and current at the Date of Bid Pricing (hereinafter referred to as “the basic prices” and the Contractor shall state in the said schedule the basic prices of such materials and goods.
- (e) If the market price of any materials or goods specified as aforesaid shall be increased or decreased after the said Date of Bid Pricing, then the net amount of difference between the basic price and the market price payable by the Contractor and current when any such goods and materials are bought shall, as the case may be, be paid to or allowed by the Contractor. Orders for materials and goods listed as aforesaid shall have been placed within a reasonable time after the date at which sufficient information is available for the placing of such orders, and the placing of orders at that time shall be a condition precedent to any payments being made to the Contractor in respect of increased market prices.”

#### SUB-CLAUSE 70.2: SUBSEQUENT LEGISLATION

Add the following to subclause 70.2:

“Notwithstanding the foregoing, such additional or reduced cost shall not be separately paid for or credited as aforesaid if the same shall already have been taken into account in accordance with the other provisions of Clause 70.

*Add the following sub clause:-*

### SUB-CLAUSE 70.3: SUB-CONTRACT

- (a) If the Contractor shall decide subject to Clause 4 thereof to sub-let any portion of the work he shall incorporate in the sub-contract provisions to the like effect as those contained in sub-clause (1) of this Clause;
- (a) If the price payable under a sub-contract as aforesaid is increased above or decreased below the price in such sub-contract by reason of the operation of the incorporated provisions of sub-clause (1) of this clause then the net amount of such increase or decrease shall as the case may be, be paid to or allowed by the Contractor under this contract.

### SUB-CLAUSE 70.4: NOMINATED SUB-CONTRACTORS

*This clause shall not apply in respect of work executed by any nominated sub-Contractor (fluctuation in relation to nominated sub-Contractors shall be dealt with under provisions in relation thereto which may be included in the appropriate sub-contract or contract of sale).*

### SUB-CLAUSE 70.5: DATE OF BID PRICING

*The expression "the date of Bid pricing" as used in this Clause means the date 30 days prior to the final date for submission of Bids as determined by the Employer in the Bid documents.*

### SUB-CLAUSE 70.6: PRIME COST

*For imported materials, the supplier's/ manufacturer's Prime costs shall be C.I.F. cost at point of entry by the same means of transport as determined by the Contractor's Basic Rate.*

*For locally produced materials, the supplier's or manufacturer's prime costs shall be at their nearest depot or the nearest railway station relevant to the works.*

*For materials which are subject to Government Price Control, payments for price variations will be determined from the difference between the control price in force at a date 30 days prior to the final date for submission of Bids and the price in force on the date of purchase.*

### SUB-CLAUSE 70.7: MATERIALS TO WHICH VARIATION CLAUSE APPLIES

*The materials to which this Variation Clause applies are as outlined in Schedule G of this Bid Document*

### SUB-CLAUSE 70.8: CHANGE OF SUPPLIER

*The Contractor shall not change the supplier or manufacturer during the Contract without the approval of the Engineer.*

### SUB-CLAUSE 70.9: CONTRACTORS HEAD OFFICE EXPENSES

*No payments will be made for price variation related to expenses incurred by the Contractor in his Head Office in Kenya, or overseas.*

### SUB-CLAUSE 70.10: CURRENCY OF PAYMENTS UNDER CLAUSE 70

*All payments made pursuant to Clause 70 shall be in Kenya Shillings.*

### SUB-CLAUSE 70.11 – COST OF PREPARING VARIATION OF PRICE CLAIMS

*No payments will be made for the cost of preparing V.O.P. claims.*

#### SUB-CLAUSE 70.12: ADJUSTMENT AFTER COMPLETION

*If the contractor fails to complete the works within the time for completion prescribed under clause 43 adjustment of prices thereafter until the date of completion of the works shall be made using the indices prices related to the prescribed time for completion.*

#### CLAUSE 73 – BRIBERY AND COLLUSION

Add new Clause 73.1:

“The Contractor shall not:

(a) Offer or give or agree to give to any person in the service of the Government of Kenya any gift or consideration or any kind as an inducement or reward for doing or forbearing to do or for having done or forborne to do any act in relation to the obtaining or execution of this or any other contract to which the Government of Kenya is a party or for showing or forbearing to show favour or disfavour to any person in relation to this or any other contract for the Government of Kenya.

(b) Enter into this or any other contract with the Government of Kenya in connection with which commission has been paid or agreed to be paid by or on his behalf or to his knowledge, unless before the contract is made particulars of any such commission and of the terms and conditions of any agreement for the payment thereof have been disclosed in writing to the Employer.

Any breach of this condition by the Contractor or by anyone employed by him or acting on his behalf (whether with or without the knowledge of the Contractor) or the commission of any offence by the Contractor or by anyone employed by him or acting on his behalf in relation to this or any other contract to which the Government of Kenya is a party shall entitle the Employer to determine the Contract (See Condition 63 hereof) and/ or to recover from the Contractor the amount or value of any such gift, consideration or commission.

Any dispute or difference of opinion arising in respect of either the interpretation, effect or application of this condition or of the amount recoverable hereunder by the Employer from the Contractor shall be decided by the Employer, whose decision shall be final and conclusive.

#### CLAUSE 74 – CONTRACT CONFIDENTIAL

Add new Clause 74.1:

The Contractor shall treat the details of this Contract as Private and Confidential and shall not publish or disclose the same or any particulars thereof in any trade or technical paper or elsewhere (save in so far as may be necessary for the purpose thereof) without the previous consent in writing of the Government. If any dispute arises as to the necessity of any publication or disclosures for the purposes of this Contract the same shall be referred to the decision of the Engineer mentioned in the said Conditions of Contract whose award shall be final.

## **SECTION XI - CONTRACT FORMS**

### **TABLE OF FORMS**

FORM No. 1 - NOTIFICATION OF INTENTION TO AWARD

FORM No. 2 - NOTIFICATION OF AWARD - LETTER OF ACCEPTANCE

FORM No. 3 - CONTRACT AGREEMENT

FORM No. 4 - PERFORMANCE SECURITY [Option 1 - Unconditional Demand Bank Guarantee]

FORM No. 5 - ADVANCE PAYMENT SECURITY

FORM No. 6 - RETENTION MONEY SECURITY

**FORM NO. I - NOTIFICATION OF INTENTION TO AWARD**

*[This Notification of Intention to Award shall be sent to each Tenderer that submitted a Tender.]*  
*[Send this Notification to the Tenderer's Authorized Representative named in the Tender Information Form]*

**FORMAT**

For the attention of Tenderer's Authorized Representative

Name: ..... *[insert Authorized Representative's name]* Address: *[insert Authorized Representative's Address]* Telephones: *[insert Authorized Representative's telephone/fax numbers]*  
Email Address: *[insert Authorized Representative's email address]*

**[IMPORTANT:** *insert the date that this Notification is transmitted to Tenderers. The Notification must be sent to all Tenderers simultaneously. This means on the same date and as close to the same time as possible.]*

**Date of Transmission:**

This Notification is sent by: *[email]* on *[date]* (local time)

Procuring Entity: *[insert the name of the Procuring entity]*

Contract title: *[insert the name of the contract]*

Country: Kenya, County \_\_\_\_\_ *(if the Procuring Entity is from a County)*

This Notification of Intention to Award (Notification) notifies you of our decision to award the above contract. The transmission of this Notification begins the Standstill Period. During the Standstill Period, you may:

- a) Request a debriefing in relation the evaluation of your Tender, and/or
- b) Submit a Procurement-related Complaint in relation to the decision to award the contract.

**1. The successful Tenderer**

Name: *[insert name of successful Tenderer]* Address: *[insert address of the successful Tenderer]*

Contract price: *[insert contract price of the successful Tender]*

**2 Other Tenderers:** *insert names of all Tenderers that submitted a Tender. If the Tender's price was evaluated include the evaluated price as well as the Tender price as read out.]*

	<b>Name of Tenderer</b>	<b>Tender price</b>	<b>Evaluated Tender price</b>	<b>Comments (if any)</b>
1				
2				
3				
4				
5				
6				
7				
Etc.				

## 1. How to request a debriefing

**DEADLINE:** The deadline to request a debriefing expires at midnight on [*insert date*] (local time).

You may request a debriefing in relation to the results of the evaluation of your Tender. If you decide to request a debriefing your written request must be made within three (3) Business Days of receipt of this Notification of Intention to Award. Provide the contract name, reference number, name of the Tenderer, contact details; and address the request for debriefing as follows:

**Attention:** [*insert full name of person, if applicable*] **Title/position:** [*insert title/position*] **Procuring Entity:** [*insert name of Procuring Entity*] **Email address:** [*insert email address*]

If your request for a debriefing is received within the 3 Business Days deadline, we will provide the debriefing within five (5) Business Days of receipt of your request. If we are unable to provide the debriefing within this period, the Standstill Period shall be extended by five (5) Business Days after the date that the debriefing is provided. If this happens, we will notify you and confirm the date that the extended Standstill Period will end. The debriefing may be in writing, by phone, video conference call or in person. We shall promptly advise you in writing how the debriefing will take place and confirm the date and time.

If the deadline to request a debriefing has expired, you may still request a debriefing. In this case, we will provide the debriefing as soon as practicable, and normally no later than fifteen (15) Business Days from the date of publication of the Contract Award Notice.

## 2. How to make a complaint

**Period:** Procurement-related Complaint challenging the decision to award shall be submitted by midnight, [*insert date*] (local time).

Provide the contract name, reference number, name of the Tenderer, contact details; and address the Procurement-related Complaint as follows:

Attention: [*insert full name of person, if applicable*]

Title/position: [*insert title/position*]

Procuring Entity: [*insert name of Procuring Entity*]

Email address: [*insert email address*]

At this point in the procurement process, you may submit a Procurement-related Complaint challenging the decision to award the contract. You do not need to have requested, or received, a debriefing before making this complaint. Your complaint must be submitted within the Standstill Period and received by us before the Standstill Period ends.

In summary, there are four essential requirements:

- a) You must be an 'interested party'. In this case, that means a Tenderer who submitted a Tender in this tendering process, and is the recipient of a Notification of Intention to Award.
- b) The complaint can only challenge the decision to award the contract.
- c) You must submit the complaint within the period stated above.
- d) You must include, in your complaint, all of the information necessary to support your case.
- e) The application must be accompanied by the fees set out in the Procurement Regulations, which shall not be refundable (information available from the Public Procurement Authority at [www.ppoa.go.ke](http://www.ppoa.go.ke)).

**3. Standstill Period**

- a) **DEADLINE:** The Standstill Period is due to end at midnight on [*insert date*] (local time).
  - i) The Standstill Period lasts ten (14) Days after the date of transmission of this Notification of Intention to Award.
  - ii) The Standstill Period may be extended as stated in Section 4 above.

If you have any questions regarding this Notification please do not hesitate to contact us. On behalf of the

Procuring Entity: \_\_\_\_\_

Name \_\_\_\_\_

Title and Position \_\_\_\_\_

Signature \_\_\_\_\_

Date \_\_\_\_\_

## **FORM NO. 2 - NOTIFICATION OF AWARD**

### **Letter of Acceptance**

*[letter head paper of the Procuring Entity]*

*[date]*

### **FORMAT**

To: *[name and address of the Contractor]*

This is to notify you that your Tender dated *[date]* for execution of the *[name of the Contract and identification number, as given in the SCC]* for the Accepted Contract Amount *[amount in numbers and words] [name of currency]*, as corrected and modified in accordance with the Instructions to Tenderers, is hereby accepted by our Agency.

You are requested to furnish the Performance Security within 30 days in accordance with the Conditions of Contract, using, for that purpose, one of the Performance Security Forms included in Section X, Contract Forms, of the tender document.

We attach a copy of the Contract for your

Authorized Signature:

Name and Title of

Signatory: Name of

Agency:

**Attachment: Contract Agreement**

**FORM NO. 3 – CONTRACT AGREEMENT**

THIS AGREEMENT made the \_\_\_\_\_ day of \_\_\_\_\_, \_\_\_\_\_, between \_\_\_\_\_ of \_\_\_\_\_ (hereinafter “the Procuring Entity”), of the one part, and \_\_\_\_\_ of \_\_\_\_\_ (herein after “the Contractor”), of the other part:

WHEREAS the Procuring Entity desires that the Works known as \_\_\_\_\_ should be executed by the Contractor, and has accepted a Tender by the Contractor for the execution and completion of these Works and the remedying of any defects therein, The Procuring Entity and the Contractor agree as follows:

1. In this Agreement words and expressions shall have the same meanings as are respectively assigned to them in the Contract documents referred to.
2. The following documents shall be deemed to form and be read and construed as part of this Agreement. This Agreement shall prevail over all other Contract documents.
  - a) The Letter of Acceptance
  - b) The Letter of Tender
  - c) The addenda Nos \_\_\_\_\_ (if any)
  - d) The Particular Conditions
  - e) The General Conditions;
  - f) The Specification
  - g) The Drawings; and
  - h) The completed Schedules and any other documents forming part of the contract.
3. In consideration of the payments to be made by the Procuring Entity to the Contractor as specified in this Agreement, the Contractor hereby covenants with the Procuring Entity to execute the Works and to remedy defects therein in conformity in all respects with the provisions of the Contract.
4. The Procuring Entity hereby covenants to pay the Contractor in consideration of the execution and completion of the Works and the remedying of defects therein, the Contract Price or such other sum as may become payable under the provisions of the Contract at the times and in the manner prescribed by the Contract.

IN WITNESS whereof the parties hereto have caused this Agreement to be executed in accordance with the laws of Kenya on the day, month and year specified above.

Signed by \_\_\_\_\_  
\_\_\_\_\_  
(for the Procuring Entity)

Signed by \_\_\_\_\_  
\_\_\_\_\_  
(for the Contractor)

**FORM NO. 4 - PERFORMANCE SECURITY**  
**– (Unconditional Demand Bank Guarantee)**

*[Guarantor letterhead or SWIFT identifier code]*

**Beneficiary:** \_\_\_\_\_ *[insert name and Address of Procuring*

*Entity]* **Date:** \_\_\_\_\_ *[Insert date of issue]*

**PERFORMANCE GUARANTEE No.:** \_\_\_\_\_

**Guarantor:** *[Insert name and address of place of issue, unless indicated in the letterhead]*

1. We have been informed that \_\_\_\_\_ (herein after called "the Applicant") has entered into Contract No. \_\_\_\_\_ dated \_\_\_\_\_ with the Beneficiary, for the execution of \_\_\_\_\_ (herein after called "the Contract").
2. Furthermore, we understand that, according to the conditions of the Contract, a performance guarantee is required.
3. At the request of the Applicant, we as Guarantor, here by irrevocably undertake to pay the Beneficiary any sum or sums not exceeding in total an amount of \_\_\_\_\_,<sup>1</sup> such sum being payable in the types and proportions of currencies in which the Contract Price is payable, upon receipt by us of the Beneficiary's complying demand supported by the Beneficiary's statement, whether in the demand itself or in a separate signed document accompanying or identifying the demand, stating that the Applicant is in breach of its obligation(s) under the Contract, without the Beneficiary needing to prove or to show grounds for your demand or the sum specified therein.
4. This guarantee shall expire, no later than the ..... Day of ..... 2...<sup>2</sup>, and any demand for payment under it must be received by us at this office indicated above on or before that date.
5. The Guarantor agrees to a one-time extension of this guarantee for a period not to exceed *[six months]* *[one year]*, in response to the Beneficiary's written request for such extension, such request to be presented to the Guarantor before the expiry of the guarantee."

\_\_\_\_\_  
*[Name of Authorized Official, signature(s) and seals/stamps]*

**Note:** *All italicized text (including footnotes) is for use in preparing this form and shall be deleted from the final product.*

<sup>1</sup>*The Guarantor shall insert an amount representing the percentage of the Accepted Contract Amount specified in the Letter of Acceptance, less provisional sums, if any, and denominated either in the currency(cies) of the Contract or a freely convertible currency acceptable to the Beneficiary.*

<sup>2</sup>*Insert the date twenty-eight days after the expected completion date as described in GC Clause 11.9. The Procuring Entity should note that in the event of an extension of this date for completion of the Contract, the Procuring Entity would need to request an extension of this guarantee from the Guarantor. Such request must be in writing and must be made prior to the expiration date established in the guarantee. In preparing this guarantee, the Procuring Entity might consider adding the following text to the form, at the end of the pen ultimate paragraph: "The Guarantor agrees to a one-time extension of this guarantee for a period not to exceed [six months] [one year], in response to the Beneficiary's written request for such extension, such request to be presented to the Guarantor before the expiry of the guarantee."*

**FORM NO. 6 - ADVANCE PAYMENT SECURITY (Not Applicable)**

**[Demand Bank Guarantee]** *[Guarantor letterhead or SWIFT*

*identifier code]* *[Guarantor letterhead or SWIFT identifier code]*

**Beneficiary:** \_\_\_\_\_ *[Insert name and Address of Procuring*

*Entity]* **Date:** \_\_\_\_\_ *[Insert date of issue]*

**ADVANCE PAYMENT GUARANTEE No.:** \_\_\_\_\_ *[Insert guarantee reference number]*

**Guarantor:** *[Insert name and address of place of issue, unless indicated in the letterhead]*

1. We have been informed that \_\_\_\_\_ (herein after called "the Applicant") has entered into Contract No. \_\_\_\_\_ dated \_\_\_\_\_ with the Beneficiary, for the execution of \_\_\_\_\_ (herein after called" the Contract").
2. Furthermore, we understand that, according to the conditions of the Contract, an advance payment in the sum \_\_\_\_\_ ( ) is to be made against an advance payment guarantee.
3. At the request of the Applicant, we as Guarantor, hereby irrevocably undertake to pay the Beneficiary any sum or sums not exceeding in total an amount of \_\_\_\_\_ ( )<sup>1</sup> upon receipt by us of the Beneficiary's complying demand supported by the Beneficiary's statement, whether in the demand itself or in a separate signed document accompanying or identifying the demand, stating either that the Applicant:
  - a) Has used the advance payment for purposes other than the costs of mobilization in respect of the Works; or
  - b) has failed to repay the advance payment in accordance with the Contract conditions, specifying the amount which the Applicant has failed to repay.
4. A demand under this guarantee may be presented as from the presentation to the Guarantor of a certificate from the Beneficiary's bank stating that the advance payment referred to above has been credited to the Applicant on its account number \_\_\_\_\_ at \_\_\_\_\_
5. The maximum amount of this guarantee shall be progressively reduced by the amount of the advance payment repaid by the Applicant as specified in copies of interim statements or payment certificates which shall be presented to us. This guarantee shall expire, at the latest, upon our receipt of a copy of the interim payment certificate indicating that ninety (90) percent of the Accepted Contract Amount, less provisional sums, has been certified for payment, or on the \_\_\_\_\_ day of \_\_\_\_\_, 20\_\_\_\_,<sup>2</sup> whichever is earlier. Consequently, any demand for payment under this guarantee must be received by us at this office on or before that date.
6. The Guarantor agrees to a one-time extension of this guarantee for a period not to exceed *[six months]* *[one year]*, in response to the Beneficiary's written request for such extension, such request to be presented to the Guarantor before the expiry of the guarantee.

*[Name of Authorized Official, signature(s) and seals/stamps]*

**Note: All italicized text (including footnotes) is for use in preparing this form and shall be deleted from the final product.**

<sup>1</sup> *The Guarantor shall insert an amount representing the amount of the advance payment and denominated either in the currency(ies) of the advance payment as specified in the Contract, or in a freely convertible currency acceptable to the Procuring Entity.*

<sup>2</sup> *Insert the expected expiration date of the Time for Completion. The Procuring Entity should note that in the event of an extension of the time for completion of the Contract, the Procuring Entity would need to request an extension of this guarantee from the Guarantor. Such request must be in writing and must be made prior*

*to the expiration date established in the guarantee. In preparing this guarantee, the Procuring Entity might consider adding the following text to the form, at the end of the penultimate paragraph: "The Guarantor agrees to a one-time extension of this guarantee for a period not to exceed [six months] [one year], in response to the Beneficiary's written request for such extension, such request to be presented to the Guarantor before the expiry of the guarantee."*

**FORM NO. 7 - RETENTION MONEY SECURITY**  
**[Demand Bank Guarantee]**

*[Guarantor letterhead]*

**Beneficiary:** \_\_\_\_\_ *[Insert name and Address of*  
Procuring Entity] **Date:** \_\_\_\_\_ *[Insert date of issue]*

**ADVANCE PAYMENT GUARANTEE No.:** \_\_\_\_\_  
*[Insert guarantee reference number]*

**Guarantor:** *[Insert name and address of place of issue, unless indicated in the letterhead]*

1. We have been informed that \_\_\_\_\_ *[insert name of Contractor, which in the case of a joint venture shall be the name of the joint venture]* (herein after called " the Contractor") has entered into Contract No. \_\_\_\_\_ *[insert reference number of the contract]* dated with the Beneficiary, for the execution of \_\_\_\_\_ *[insert name of contract and brief description of Works]* (herein after called " the Contract").
2. Furthermore, we understand that, according to the conditions of the Contract, the Beneficiary retains moneys up to the limit set forth in the Contract ("the Retention Money"), and that when the Taking-Over Certificate has been issued under the Contract and the first half of the Retention Money has been certified for payment, and payment of *[insert the second half of the Retention Money]* is to be made against a Retention Money guarantee.
3. At the request of the Contractor, we, as Guarantor, hereby irrevocably undertake to pay the Beneficiary any sum or sums not exceeding in total an amount of *[insert amount in figures]* (*[insert amount in words* \_\_\_\_\_ *]*)<sup>1</sup> upon receipt by us of the Beneficiary's complying demand supported by the Beneficiary's statement, whether in the demand itself or in a separate signed document accompanying or identifying the demand, stating that the Contractor is in breach of its obligation(s) under the Contract, without your needing to prove or show grounds for your demand or the sum specified therein.
4. A demand under this guarantee may be presented as from the presentation to the Guarantor of a certificate from the Beneficiary's bank stating that the second half of the Retention Money as referred to above has been credited to the Contractor on its account number\_at \_\_\_\_\_ *[insert name and address of Applicant's bank]*.
5. This guarantee shall expire no later than the..... Day of....., 2...<sup>2</sup>, and any demand for payment under it must be received by us at the office indicated above on or before that date.
6. The Guarantor agrees to a one-time extension of this guarantee for a period not to exceed *[six months]* *[one year]*, in response to the Beneficiary's written request for such extension, such request to be presented to the Guarantor before the expiry of the guarantee.

---

*[Name of Authorized Official, signature(s) and seals/stamps]*

**Note: All italicized text (including foot notes) is for use in preparing this form and shall be deleted from the final product.**

**FORM NO. 8 BENEFICIAL OWNERSHIP DISCLOSURE FORM**

**INSTRUCTIONS TO TENDERERS: DELETE THIS BOX ONCE YOU HAVE COMPLETED THE FORM**

*This Beneficial Ownership Disclosure Form ("Form") is to be completed by the successful tenderer. In case of joint venture, the tenderer must submit a separate Form for each member. The beneficial ownership information to be submitted in this Form shall be current as of the date of its submission.*

*For the purposes of this Form, a Beneficial Owner of a Tenderer is any natural person who ultimately owns or controls the Tenderer by meeting one or more of the following conditions:*

- *Directly or indirectly holding 25% or more of the shares.*
- *Directly or in directly holding 25% or more of the voting rights.*
- *Directly or indirectly having the right to appoint a majority of the board of directors or equivalent governing body of the Tenderer.*

Tender Reference No.: \_\_\_\_\_ [insert identification no] Name of the Assignment: \_\_\_\_\_ [insert name of the assignment] to: \_\_\_\_\_ [insert complete name of Procuring Entity]

In response to your notification of award dated \_\_\_\_\_ [insert date of notification of award] to furnish additional information on beneficial ownership: \_\_\_ [select one option as applicable and delete the options that are not applicable]

I) We here by provide the following beneficial ownership information.

**Details of beneficial ownership**

<b>Identity of Beneficial Owner</b>	<b>Directly or indirectly holding 25% or more of the shares</b>  <b>(Yes / No)</b>	<b>Directly or indirectly holding 25 % or more of the Voting Rights</b>  <b>(Yes / No)</b>	<b>Directly or indirectly having the right to appoint a majority of the board of the directors or an equivalent governing body of the Tenderer</b>  <b>(Yes / No)</b>
<i>[include full name (last, middle, first), nationality, country of residence]</i>			

OR

ii) We declare that there is no Beneficial Owner meeting one or more of the following

*conditions: directly or indirectly holding 25% or more of the shares. Directly or indirectly holding 25% or more of the voting rights. Directly or indirectly having the right to appoint a majority of the board of directors or equivalent governing body of the Tenderer.*

*OR*

*We declare that we are unable to identify any Beneficial Owner meeting one or more of the following conditions. [If this option is selected, the Tenderer shall provide explanation on why it is unable to identify any Beneficial Owner]*

*Directly or indirectly holding 25% or more of the shares. Directly or indirectly holding 25% or more of the voting rights.*

*Directly or indirectly having the right to appoint a majority of the board of directors or equivalent governing body of the Tenderer]”*

*Name of the Tenderer: .....\*[insert complete name of the Tenderer]\_\_\_\_\_*

*Name of the person duly authorized to sign the Tender on behalf of the Tenderer: \*\* [insert complete name of person duly authorized to sign the Tender]*

*Title of the person signing the Tender: ..... [insert complete title of the person signing the Tender]*

*Signature of the person named above: ..... [insert signature of person whose name and capacity are shown above]*

*Date signed ..... [insert date of signing] day of..... [Insert month], [insert year]*





**PERIODIC MAINTENANCE OF KAMPI YA MOTO - EMINING (B17) ROAD**

**Supervision Check List**

Project Name: **PERIODIC MAINTENANCE OF KAMPI YA MOTO - EMINING (B17) ROAD**

Date	Signatures
------	------------

		with Works Execution Programme											
		2-2 All equipment used is well maintained during the execution of works		<input type="checkbox"/>	<input type="checkbox"/>	<input type="checkbox"/>	<input type="checkbox"/>	<input type="checkbox"/>	<input type="checkbox"/>	<input type="checkbox"/>	<input type="checkbox"/>		
3	Contractor's in-house staff	3-1 Qualified technical staff of Contractor are properly assigned as specified in Works Execution Programme		<input type="checkbox"/>	<input type="checkbox"/>	<input type="checkbox"/>	<input type="checkbox"/>	<input type="checkbox"/>	<input type="checkbox"/>	<input type="checkbox"/>	<input type="checkbox"/>		
		3-2 Contractor's in-house key staff understand work process		<input type="checkbox"/>	<input type="checkbox"/>	<input type="checkbox"/>	<input type="checkbox"/>	<input type="checkbox"/>	<input type="checkbox"/>	<input type="checkbox"/>	<input type="checkbox"/>		





**PERIODIC MAINTENANCE OF KAMPI YA MOTO - EMINING (B17) ROAD**

**Supervision Check List**

Project Name: **PERIODIC MAINTENANCE OF KAMPI YA MOTO - EMINING (B17) ROAD**

Date	Signatures
------	------------

			managed during the work execution											
6	Quality and quantity management	6-1	Material testing, structural examination, and measurements are properly and PERIODICLY conducted based on specifications and Works Execution Programme		<input type="checkbox"/>	<input type="checkbox"/>	<input type="checkbox"/>	<input type="checkbox"/>	<input type="checkbox"/>	<input type="checkbox"/>	<input type="checkbox"/>	<input type="checkbox"/>		
		6-2	Results of material testing, structural examination and measurement		<input type="checkbox"/>	<input type="checkbox"/>	<input type="checkbox"/>	<input type="checkbox"/>	<input type="checkbox"/>	<input type="checkbox"/>	<input type="checkbox"/>	<input type="checkbox"/>		



**PERIODIC MAINTENANCE OF KAMPI YA MOTO - EMINING (B17) ROAD**

**Supervision Check List**

Project Name: **PERIODIC MAINTENANCE OF KAMPI YA MOTO - EMINING (B17) ROAD**

Date	Signatures
------	------------

		periodically compared to the planned schedule described in Works Execution Programme											
	7-3	Changes caused by site conditions are properly handled to keep things on schedule		<input type="checkbox"/>	<input type="checkbox"/>	<input type="checkbox"/>	<input type="checkbox"/>	<input type="checkbox"/>	<input type="checkbox"/>	<input type="checkbox"/>	<input type="checkbox"/>		
	7-4	All works are completed within the contract term or within the extended term as allowed										<input type="checkbox"/>	



**PERIODIC MAINTENANCE OF KAMPI YA MOTO - EMINING (B17) ROAD**

**Supervision Check List**

Project Name: **PERIODIC MAINTENANCE OF KAMPI YA MOTO - EMINING (B17) ROAD**

Date	Signatures
------	------------

			are constantly checked												
9	Environmental and social management	9-1	Environmental and social mitigation efforts (e.g. against noise, vibration, emission, and dust ) are conducted		<input type="checkbox"/>	<input type="checkbox"/>	<input type="checkbox"/>	<input type="checkbox"/>	<input type="checkbox"/>	<input type="checkbox"/>	<input type="checkbox"/>	<input type="checkbox"/>			
		9-2	Waste material from site is properly disposed		<input type="checkbox"/>	<input type="checkbox"/>	<input type="checkbox"/>	<input type="checkbox"/>	<input type="checkbox"/>	<input type="checkbox"/>	<input type="checkbox"/>	<input type="checkbox"/>	<input type="checkbox"/>		
		9-3	Damage to existing roads, works and services is avoided or are repaired		<input type="checkbox"/>	<input type="checkbox"/>	<input type="checkbox"/>	<input type="checkbox"/>	<input type="checkbox"/>	<input type="checkbox"/>	<input type="checkbox"/>	<input type="checkbox"/>	<input type="checkbox"/>		



**PERIODIC MAINTENANCE OF KAMPI YA MOTO - EMINING (B17) ROAD**